

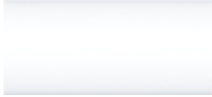









PRICELIST  
**EXTERNAL BLINDS**  
**PLEATED MOSQUITO NET**  
**PERGOLA**  
PORTOS



# COLOURS

			ZF3000 TP1000K-ZF	PR6000
WHITE		RAL 9016	✓	✓
BEIGE		VSR 240	✓	*
LIGHT GRAY		RAL 7035 MATT	✓	*
SILVER		RAL 9006	✓	*
GRAY ALUMINIUM		RAL 9007	✓	*
STEEL ANTHRACITE		DB 703	✓	*
ANTHRACITE		RAL 7016 MATT	✓	✓
DARK ANTHRACITE		RAL 7021 MATT **	✓	✓
OLIVE		VSR 780	✓	*
BROWN		RAL 8014 MATT **	✓	*
BLACK		RAL 9005 MATT	✓	*

\* - Colour surcharge. Pergolas are also available in any RAL colour for an additional surcharge.

Gloss level of RAL colours available for pergolas is STRUCTURE MATT.

\*\* - The color MATT refers only to Z90 slats

# TABLE OF CONTENTS

<b>DIMENSIONING</b> .....	5,7,9,11,13
<b>PRICE LIST</b> .....	16
<b>EXTERNAL BLIND C80 - CORD LEADING / ELECTRICAL CONTROL</b> .....	16
<b>EXTERNAL BLIND C80 - ALUMINIUM GUIDES / ELECTRICAL CONTROL</b> .....	18
<b>EXTERNAL BLIND Z90 - CORD LEADING / ELECTRICAL CONTROL</b> .....	20
<b>EXTERNAL BLIND Z90 - ALUMINIUM GUIDES / ELECTRICAL CONTROL</b> .....	22
<b>EXTERNAL BLIND BXC80 - ALUMINIUM GUIDES/ ELECTRICAL CONTROL/ TYPE A, B</b> .....	24
<b>EXTERNAL BLIND BXC80 - ALUMINIUM GUIDES/ ELECTRICAL CONTROL/ TYPE C, D</b> .....	26
<b>EXTERNAL BLIND BXZ90 - ALUMINIUM GUIDES/ ELECTRICAL CONTROL/ TYPE A, B</b> .....	28
<b>EXTERNAL BLIND BXZ90 - ALUMINIUM GUIDES/ ELECTRICAL CONTROL/ TYPE C, D</b> .....	30
<b>EXTERNAL BLIND BX - EMPTY CASE / TYPE A,B,C,D</b> .....	32
<b>EXTERNAL BLINDS IN THE BOX TP1000K-ZF C80 – WHITE</b> .....	34
<b>EXTERNAL BLINDS IN THE BOX TP1000K-ZF C80 – WHITE / DECOR</b> .....	36
<b>EXTERNAL BLINDS IN THE BOX TP1000K-ZF C80 – DECOR</b> .....	38
<b>EXTERNAL BLINDS IN THE BOX TP1000K-ZF Z90 – WHITE</b> .....	40
<b>EXTERNAL BLINDS IN THE BOX TP1000K-ZF Z90 – WHITE / DECOR</b> .....	42
<b>EXTERNAL BLINDS IN THE BOX TP1000K-ZF Z90 – DECOR</b> .....	44
<b>EXTERNAL BLINDS IN THE BOX TP1000K-ZF EMPTY BOX</b> .....	46
<b>PERGOLA PR6000 HT</b> .....	48
<b>PERGOLA PR6000 LITE</b> .....	50
<b>PLEATEDMOSQUITONET</b> .....	51
<b>SAFETY PLATES</b> .....	52
<b>PRICE LIST OF ADDITIONAL COMPONENTS</b> .....	56
<b>PRICE LIST OF CONTROL ELEMENTS</b> .....	58
<b>MINIMUM DIMENSIONS OF EXTERNAL BLINDS AND EXTERNAL BLIND BX</b> .....	61
<b>ORDERFORM/ EXPLANATIONS ZF3000</b> .....	62
<b>ORDERFORM/ EXPLANATIONS TP1000K-ZF</b> .....	64
<b>ORDERFORM/ EXPLANATIONS PR6000</b> .....	66
<b>ORDERFORM/ EXPLANATIONS PLEATEDMOSQUITONET</b> .....	68
<b>TECHNOLOGICAL AND OPERATIONAL DOCUMENTATION</b> .....	71
<b>GENERAL SALE CONDITIONS</b> .....	72
<b>COMPLAINT FORM</b> .....	73
<b>COLOURS OF VENEER</b> .....	74



# ZF3000 EXTERNAL BLIND

## DIMENSIONING - CORD LEADING

### INSTALLATION IN THE WINDOW RECESS

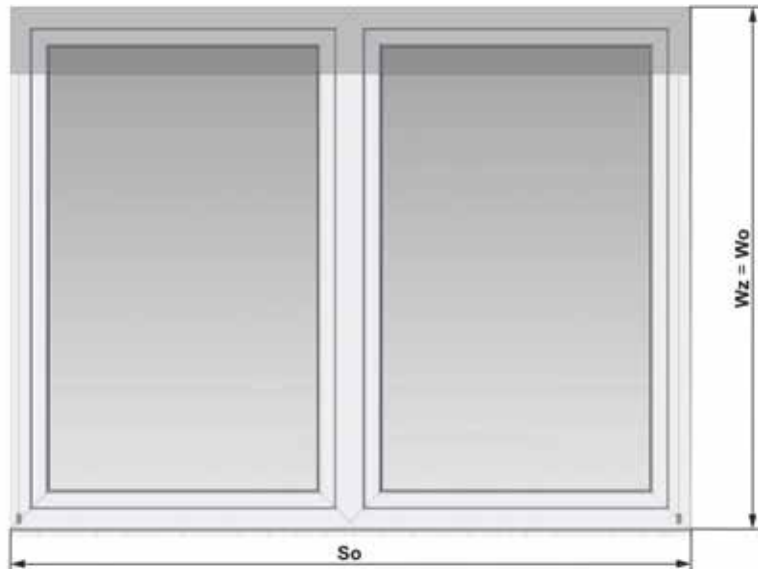

- Sz** - blind width (slat width)
- So** - hole width
- Wz** - blind height
- Wo** - hole height
- Sz = So** - installation clearance (1 cm per side)
- Wz = Wo**

### INSTALLATION ON THE FACADE/FLUSH-MOUNTED

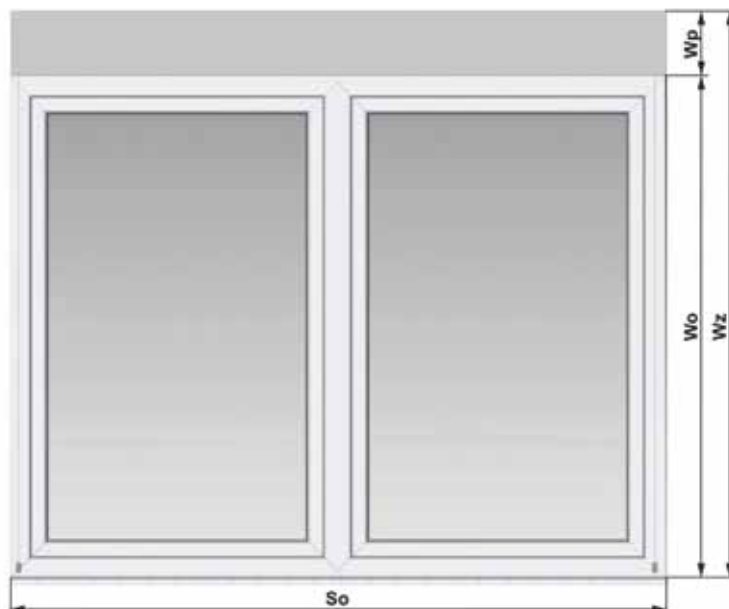

- Sz** - blind width (slat width)
- So** - hole width
- Wz** - blind height
- Wo** - hole height
- Wp** - package height
- Wbo** - height of the safety plate
- Wz = Wo + Wp\*** or **Wbo**

INSTALLATION ON THE FACADE:

**Sz = So** + slat overlap on the facade

FLUSH-MOUNTED:

**Sz = window width\*\***

### NOTE

IN THE CASE OF INSTALLATION IN THE WINDOW RECESS, MAKE SURE THE RECESS WIDTH AND HEIGHT ARE EQUAL IN ALL POINTS. IF THEY ARE DIFFERENT, ASSUME THE DIMENSION OF THE MINIMUM OR MAKE A PROPER CORRECTION OF THE HOLE.

IF SEVERAL EXTERNAL BLIND SETS ARE ORDERED, THE FOLLOWING RULE OF FILLING IN ORDERS SHALL BE OBSERVED: FIRST FILL IN THE INFORMATION ON LEFT SIDE BLINDS AND THEN IN ORDER FROM LEFT TO RIGHT WHEN LOOKING FROM INSIDE THE ROOM.

\* - When adding the package height and subsequent adding a higher safety plate - the plate may enter the frame opening/hole.

\*\* - It is recommended to take into account the installation clearance for free operation of the blind.



# ZF3000 EXTERNAL BLIND

## DIMENSIONING - ALUMINIUM GUIDES

### INSTALLATION IN THE WINDOW RECESS

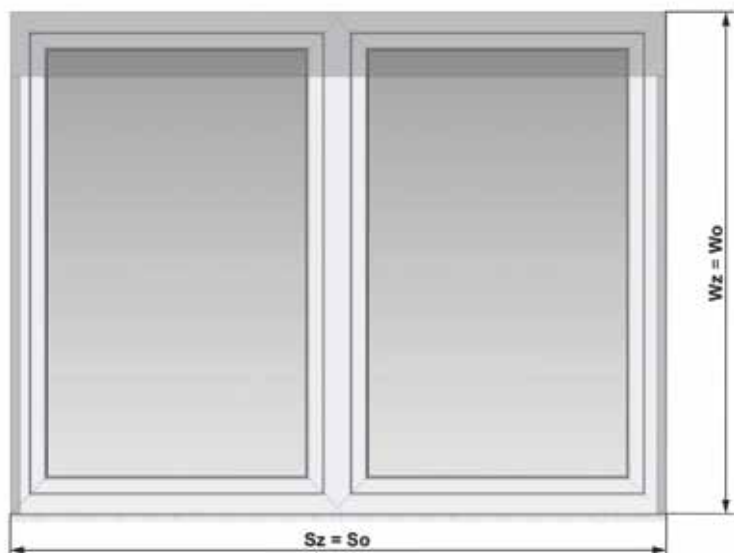

**Sz** - blind width  
**So** - hole width  
**Wz** - blind height  
**Wo** - hole height  
**Sz = So**  
**Wz = Wo**

### INSTALLATION ON THE FACADE/FLUSH-MOUNTED

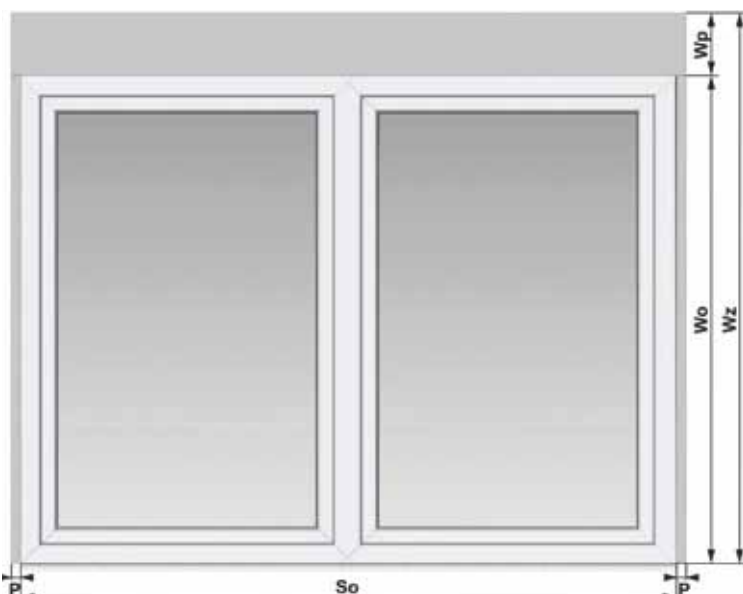

**Sz** - blind width  
**So** - hole width  
**Wz** - blind height  
**Wo** - hole height  
**Wp** - package height  
**P** - guide width (20 mm)  
**Wbo** - height of the safety plate  
**Wz = Wo + Wp\*** or **Wbo**  
INSTALLATION ON THE FACADE:  
**Sz = So + 2 x P**  
FLUSH-MOUNTED:  
**Sz = window width\*\***

### NOTE

IN THE CASE OF INSTALLATION IN THE WINDOW RECESS, MAKE SURE THE RECESS WIDTH AND HEIGHT ARE EQUAL IN ALL POINTS. IF THEY ARE DIFFERENT, ASSUME THE DIMENSION OF THE MINIMUM OR MAKE A PROPER CORRECTION OF THE HOLE. IF SEVERAL EXTERNAL BLIND SETS ARE ORDERED, THE FOLLOWING RULE OF FILLING IN ORDERS SHALL BE OBSERVED: FIRST FILL IN THE INFORMATION ON LEFT SIDE BLINDS AND THEN IN ORDER FROM LEFT TO RIGHT WHEN LOOKING FROM INSIDE THE ROOM.

\* - When adding the package height and subsequent adding a higher safety plate - the plate may enter the frame opening/hole.

\*\* - It is recommended to take into account the installation clearance for free processing of wood elements.



# ZF3000-BX, TP1000K-ZF EXTERNAL BLIND

## DIMENSIONING - ALUMINIUM GUIDES FOR FLUSH-MOUNTED INSTALLATION

### INSTALLATION IN THE WINDOW RECESS (ZF3000-BX)

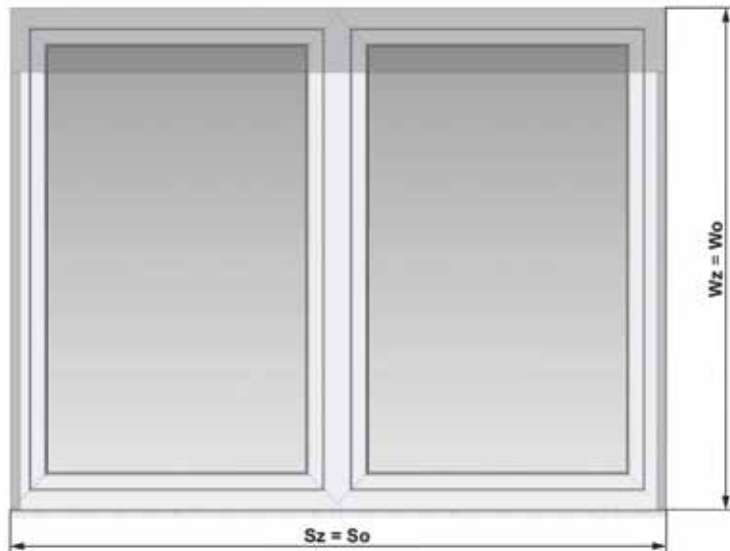

- Sz** - blind width
- So** - hole width
- Wz** - blind height
- Wo** - height of the hole together with the box height
- Sz = So\***
- Wz = Wo**

### INSTALLATION ON THE FACADE/FLUSH-MOUNTED (ZF3000-BX) INSTALLED TO WINDOW FRAMES (TP1000K-ZF)

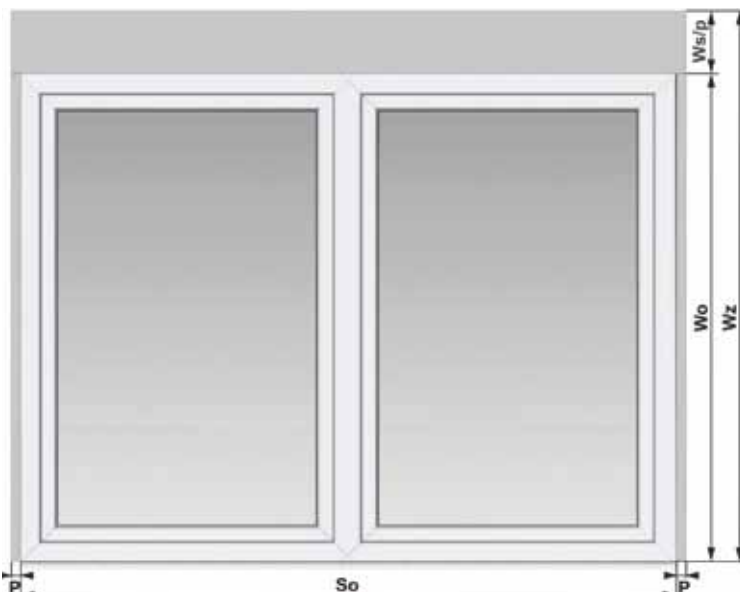

- Sz** - blind width
- So** - hole width
- Wz** - blind height
- Ws** - box height
- Ws/p** - height of the box (+ can be optionally elevated by 30 mm in TP1000K-ZF)
- Wo** - hole height
- Wk** - height of the window
- P** - guide width (27 mm)

$$\mathbf{Wz = Wo + Ws}$$
$$\mathbf{Wz^{**} = Wk + Ws/p}$$

Installation on the facade:

$$\mathbf{Sz = So + 2 \times P}$$

Flush-mounted installation:

$$\mathbf{Sz = \text{window width}^*}$$

Installed to the window frame:

$$\mathbf{Sz = \text{window width}^*}$$

### NOTE

IN THE CASE OF INSTALLATION IN THE WINDOW RECESS, MAKE SURE THE RECESS WIDTH AND HEIGHT ARE EQUAL IN ALL POINTS. IF THEY ARE DIFFERENT, ASSUME THE DIMENSION OF THE MINIMUM OR MAKE A PROPER CORRECTION OF THE HOLE. IF SEVERAL EXTERNAL BLIND SETS ARE ORDERED, THE FOLLOWING RULE OF FILLING IN ORDERS SHALL BE OBSERVED: FIRST FILL IN THE INFORMATION ON LEFT SIDE BLINDS AND THEN IN ORDER FROM LEFT TO RIGHT WHEN LOOKING FROM INSIDE THE ROOM.

\* - It is recommended to take into account the installation clearance for free processing of wood elements.

\*\* - Refers to the TP1000K-ZF box (if the TP1000K-ZF box is lowered, the total height of the product does not increase).



# ZF3000-BX EXTERNAL BLIND

## DIMENSIONING - CORNER VERSION WITH A CORNER GUIDE/ A LEADING CORD

### INSTALLATION ON THE FACADE/FLUSH-MOUNTED

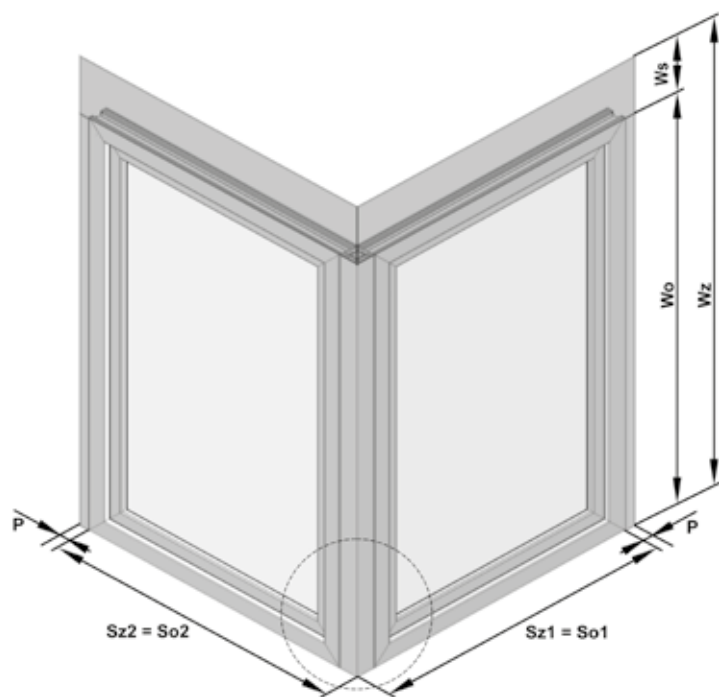

### INSTALLATION OF THE VERSION WITH A LEADING CORD\*

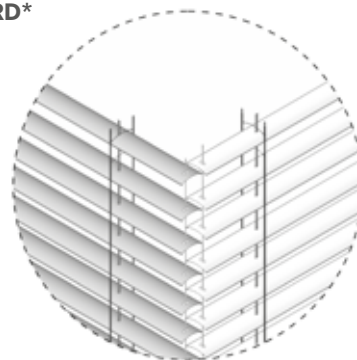

### INSTALLATION OF THE VERSION WITH A CORNER GUIDE

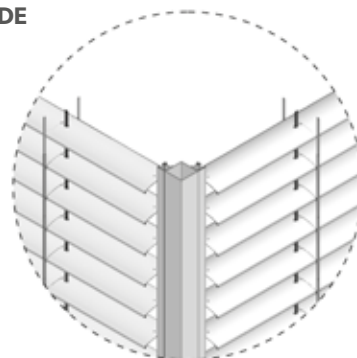

**Sz** - blind width

**So** - hole width/window frame with a connector (do not measure that part of the connector that protrudes from the window frame)

**Wz** - blind height

**Ws** - box height

**Wo** - hole height

**P** - guide width (27 mm)

**Wz = Wo + Ws** (-2 cm to prevent any gaps between the window frame and the box)

Installation on the facade:

**Sz = So + P**

Flush-mounted:

**Sz = window width\*\***

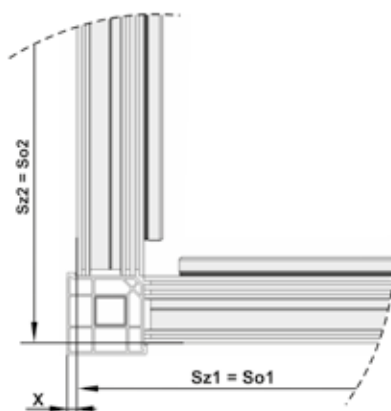
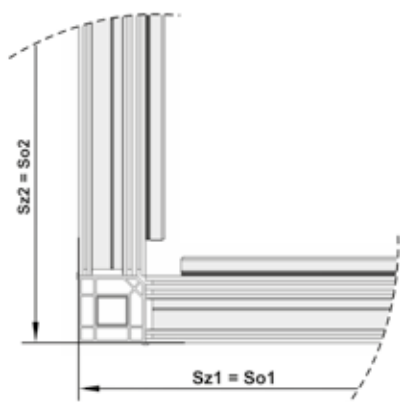

### NOTE

IN THE CASE OF INSTALLATION OF THE VERSION WITH A CORNER GUIDE, "X" DISTANCE, BY WHICH THE CORNER CONNECTOR PROTRUDES FROM THE WINDOW FRAME, SHALL BE ADDITIONALLY PROVIDED.

IF SEVERAL EXTERNAL BLIND SETS ARE ORDERED, THE FOLLOWING RULE OF FILLING IN ORDERS SHALL BE OBSERVED: FIRST FILL IN THE INFORMATION ON LEFT SIDE BLINDS AND THEN IN ORDER FROM LEFT TO RIGHT WHEN LOOKING FROM INSIDE THE ROOM.

\* - A reference drawing shows one of the blinds package as a package with the main slat profile (protruding profile)

\*\* - It is recommended to take into account the installation clearance for free processing of wood elements and proper installation of the guides.



# PERGOLA PR6000

## DIMENSIONING

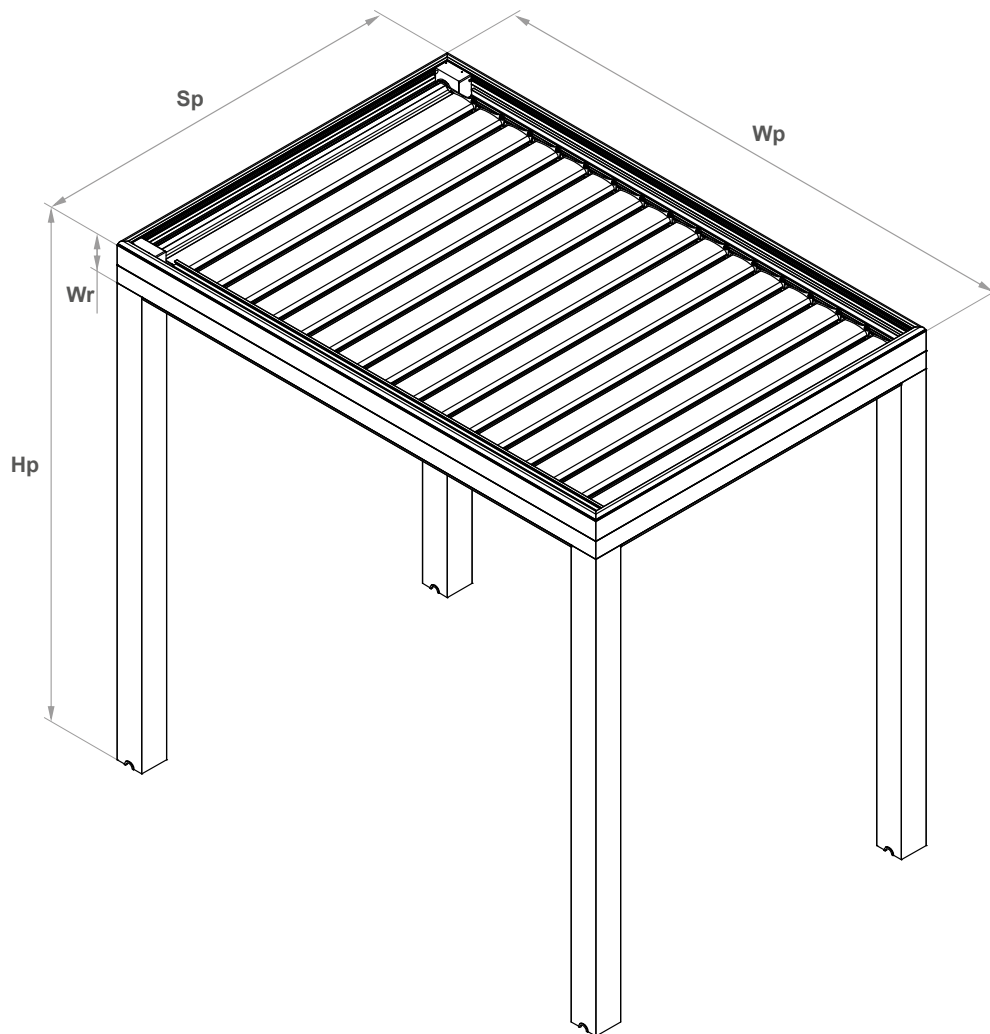

**Sp** - width of the pergola  
**Wp** - pergola outreach  
**Hp** - height of the pergola  
**Wr** - gutter height:  
PR6000-HT = 220 mm  
PR6000 LITE = 170 mm





## EXTRA CHARGE

Maximum area	16 m <sup>2</sup>
Minimum width *	560 mm
Minimum height	600 mm
Maximum width	4000 mm
Maximum height	5000 mm

### STANDARD EQUIPMENT

Wall handles	F-US-120
Top rail handles	F-USG
Cord guide	F-PL
Cord guide lower handles	F-UDPL-80
Slat rotation	90°/180°

SYMBOL	NAME	PRICE
F-US-100-150	Adjustable wall handle 100-150 mm	5,40 €
F-US-150-200	Adjustable wall handle 150-200 mm	6,20 €
F-US-200-250	Adjustable wall handle 200-250 mm	7,10 €
F-USG-A	Automatic top rail handle	1,70 €
F-UDPL-120	Cord guide lower handle 120 mm	1,10 €
F-UDPL-150	Cord guide lower handle 150 mm	1,70 €
F-UDPP	Cord guide lower handle attached to the floor	2,80 €
F-WN	Drive shaft connector	18,90 €

\* - detailed table of minimum widths on p. 61.

### HANDLES MOUNTING THE HEAD RAIL

SAFETY PLATE	PACKAGE HEIGHT	h/w	2 TOP RAIL HANDLES								3 TOP RAIL HANDLES								
			600-1000	1001-1100	1101-1200	1201-1300	1301-1400	1401-1500	1501-1600	1601-1700	1701-1800	1801-1900	1901-2000	2001-2100	2101-2200	2201-2300	2301-2400	2401-2500	
200	190	600-1000	293	302	305	314	323	341	351	360	363	366	370	380	384	388	391	415	
		1001-1100	295	304	308	323	326	345	354	363	366	371	375	385	389	393	397	420	
		1101-1200	299	309	312	327	332	350	361	370	374	378	382	394	398	402	406	431	
250	200	1201-1300	301	317	321	331	335	354	364	374	378	382	387	398	403	407	411	436	
		1301-1400	303	319	324	334	338	357	368	378	382	386	391	403	407	412	417	442	
	220	1401-1500	313	324	328	338	343	363	375	385	389	394	399	411	416	421	426	452	
		1501-1600	315	332	337	348	353	373	385	395	400	406	411	423	429	434	439	466	
	230	1601-1700	317	335	340	351	355	377	389	399	405	410	416	428	433	439	444	472	
		1701-1800	322	339	345	356	361	383	396	406	412	417	423	437	442	449	454	482	
300	250	1801-1900	324	342	348	359	365	386	399	410	416	422	428	442	448	453	460	488	
		1901-2000	328	346	352	364	370	393	406	417	424	430	436	450	457	463	469	498	
	260	2001-2100	336	355	362	373	380	404	417	429	435	442	449	464	470	477	483	514	
		2101-2200	339	358	364	376	383	407	421	433	440	446	453	468	475	482	489	519	
	270	2201-2300	343	362	369	381	389	413	428	440	447	455	462	477	484	492	499	530	
		2301-2400	345	365	372	385	392	417	432	444	451	458	466	482	490	497	504	536	
	280	2401-2500	349	369	377	390	398	423	439	451	459	467	475	491	499	507	515	546	
		2501-2600	358	379	387	400	427	434	450	464	472	480	488	514	522	550	558	572	
	340	300	2601-2700	360	381	390	403	430	438	454	468	476	484	492	519	528	556	564	579
			2701-2800	364	386	395	409	436	444	461	475	483	492	501	528	537	566	575	590
310		2801-2900	366	389	398	412	439	448	465	479	488	497	505	533	542	572	581	596	
		2901-3000	371	393	403	417	446	455	472	487	495	505	514	543	552	582	592	607	
320		3001-3100	380	403	413	428	457	466	493	508	518	528	538	557	567	598	608	624	
		3101-3200	383	406	416	431	461	470	497	513	523	532	543	562	572	604	614	630	
370	340	3201-3300	387	411	421	436	467	477	504	521	531	541	552	572	583	615	625	642	
		3301-3400	389	414	424	440	470	480	508	525	535	546	556	577	588	621	631	648	
	350	3401-3500	391	416	427	443	473	484	513	529	540	550	561	582	593	627	637	654	
3501-3600		425	436	448	486	497	508	529	546	557	569	580	625	636	648	660	678		
440	370	3601-3700	428	439	450	490	501	512	533	551	562	574	585	630	642	654	666	684	
		3701-3800	432	444	456	496	507	519	541	558	570	582	594	641	652	665	678	695	
	380	3801-3900	435	446	459	499	511	523	544	563	575	587	599	646	658	671	683	696	
		3901-4000	437	449	462	502	515	527	548	566	579	592	604	651	664	676	684	703	
	400	4001-4100	450	462	475	517	530	543	566	584	598	611	624	672	686	695	708	773	
		4101-4200	452	465	479	521	534	547	570	589	602	616	629	678	692	701	714	779	
	410	4201-4300	457	470	484	527	540	554	577	597	611	624	638	688	697	712	771	791	
		4301-4400	460	473	487	531	545	558	581	601	616	629	643	689	704	763	777	798	
	430	4401-4500	462	476	490	534	548	562	586	606	620	634	648	695	755	769	784	804	
		4501-4600	475	490	504	550	564	579	604	624	639	654	665	718	779	793	809	830	
480	440	4601-4700	478	493	507	553	568	583	608	629	644	655	670	769	784	799	815	837	
		4701-4800	483	498	513	560	575	590	616	637	653	664	724	779	795	811	826	849	
	450	4801-4900	486	501	516	563	579	594	620	642	653	669	730	785	801	817	833	855	
4901-5000		488	504	520	567	583	598	624	646	658	674	735	790	807	823	839	862		

The heights of packages concern the 180° rotation.

## EXTRA CHARGES FOR MOTORS

NAME	6 Nm	9 Nm	10 Nm	18 Nm	20 Nm
AM55 / VB55	VB55-6/22EL Included in the price	-	AM55-10/35-EL Included in the price	-	-
ELERO SOFT	JA 06 SOFT Included in the price	JA 09 SOFT Included in the price	-	-	JA 20 DK Included in the price
SOMFY WT	J406 6/24 WT 39,40 €	-	J410 10/24 WT 40,50 €	J418 18/24 WT 62,90 €	-
SOMFY WT PROTECT	J406 6/24 WT PROTECT 74,70 €	-	J410 10/24 WT PROTECT 51,90 €	J418 18/24 WT PROTECT 82 €	-
ELERO COMFORT	JA 06 COMFORT 868 131,70 €	JA 09 COMFORT 868 157,40 €	-	-	-
SOMFY RTS	J406 6/24 RTS 171,70 €	-	J410 10/24 RTS 183,20 €	J418 18/24 RTS 208,90 €	-
SOMFY IO PROTECT	J406 6/24 IO PROTECT 171,70 €	-	J410 10/24 IO PROTECT 183,20 €	J418 18/24 IO PROTECT 208,90 €	-
ELERO NHK	-	JA 09 NHK ZESTAW* 878,10 €	-	-	-

\* - Product for special order

CRANK MECHANISM (set) - 20,60 €

CRANK STEM EXTENSION - 14,20 €/m

The price given in the table does not include safety plates.

Price list of safety plates is available on p. 52-55.

Price list of additional components for external blinds is available on p. 56.

### HANDLES MOUNTING THE HEAD RAIL

4 TOP RAIL HANDLES								5 TOP RAIL HANDLES						
2501-2600	2601-2700	2701-2800	2801-2900	2901-3000	3001-3100	3101-3200	3201-3300	3301-3400	3401-3500	3501-3600	3601-3700	3701-3800	3801-3900	3901-4000
426	429	433	437	441	462	466	470	479	498	520	524	528	537	541
432	436	440	444	448	469	473	477	487	506	528	533	537	546	551
443	447	451	455	460	482	487	491	501	521	544	549	554	564	568
449	453	457	462	466	489	494	498	508	529	553	557	563	573	578
455	459	464	469	473	496	501	506	516	537	561	566	571	582	587
465	470	475	480	485	509	514	519	530	552	577	582	588	599	604
480	486	490	496	501	534	540	546	557	580	596	602	607	619	624
486	491	497	502	508	542	548	554	565	588	605	610	617	628	634
497	503	508	515	521	555	561	568	580	604	621	627	633	645	651
503	509	515	521	527	563	569	576	587	612	630	636	643	655	661
514	521	527	533	540	577	583	590	602	627	646	652	659	672	679
539	546	553	560	567	594	601	608	621	647	666	673	680	694	701
545	553	559	567	574	601	609	616	629	655	675	682	690	703	710
557	564	572	579	587	615	623	631	644	671	691	699	707	721	729
563	571	579	586	594	622	631	639	652	680	700	708	716	730	738
575	583	591	599	607	636	645	653	667	696	717	725	733	748	756
591	600	608	617	626	655	665	685	693	708	716	738	747	756	771
598	606	615	624	633	663	693	701	716	725	747	756	765	775	785
609	618	628	637	646	677	707	717	732	742	764	773	778	794	803
616	626	635	644	653	685	715	725	741	750	768	778	788	803	858
628	637	647	657	667	698	730	740	751	761	785	795	850	867	877
645	656	666	676	686	719	751	762	773	784	809	864	875	892	902
652	662	673	683	693	726	759	765	782	838	863	874	885	901	912
664	675	686	696	707	741	770	781	843	854	880	891	903	920	932
670	682	693	704	709	744	778	834	852	863	889	901	912	930	941
677	688	699	705	717	752	831	843	861	872	898	910	922	940	951
701	713	720	756	812	849	861	873	892	903	947	960	972	991	1 003
708	715	727	808	820	857	869	882	900	912	956	969	982	1 001	1 065
716	728	786	822	834	872	885	897	916	929	974	987	1 001	1 071	1 085
722	780	793	829	842	880	892	906	925	938	984	1 047	1 061	1 082	1 096
774	787	800	837	850	888	901	914	934	947	1 043	1 057	1 072	1 093	1 320
800	813	827	865	879	934	948	962	983	1 047	1 062	1 076	1 091	1 326	
807	820	834	873	887	942	956	971	1 041	1 057	1 072	1 299	1 315		
819	833	848	887	902	958	972	1 037	1 059	1 075	1 303	1 319			
826	840	855	895	909	966	1 030	1 046	1 069	1 297	1 313				
833	847	862	903	917	1 023	1 039	1 056	1 291	1 307					
874	890	905	948	1 012	1 040	1 056	1 285	1 309						
881	897	913	1 004	1 021	1 048	1 277	1 294	1 318						
894	910	973	1 019	1 037	1 277	1 294	1 312							
901	963	981	1 028	1 257	1 286	1 304								
908	971	989	1 247	1 266	1 295	1 313								

- BLIND MOTOR 6 Nm
- BLIND MOTOR 9 Nm
- BLIND MOTOR 10 Nm
- BLIND MOTOR 20 Nm

## EXTRA CHARGE

Maximum area	16 m <sup>2</sup>
Minimum width (F-PP guides) *	560 mm
Minimum width (F-FBR guides) *	574 mm
Minimum height	600 mm
Maximum width	4500 mm
Maximum height	5000 mm

### STANDARD EQUIPMENT

Wall handles	F-US-120
Top rail handles	F-USG
Guides	F-PP-20
Aluminium guide handles	F-UPP-50-70
Slat rotation	90°/180°

SYMBOL	NAME	PRICE
F-US-100-150	Adjustable wall handle 100-150 mm	5,40 €
F-US-150-200	Adjustable wall handle 150-200 mm	6,20 €
F-US-200-250	Adjustable wall handle 200-250 mm	7,10 €
F-USG-A	Automatic top rail handle	1,70 €
F-UPP-71-100	Straight guide handle 71-100 mm	0,90 €
F-UPP-101-145	Straight guide handle 101-145 mm	1,90 €
F-UPT-50-70	Telescopic guide handle 50-70 mm	6,60 €
F-UPT-71-105	Telescopic guide handle 71-105 mm	8,00 €
F-UPT-106-170	Telescopic guide handle 106-170 mm	11,00 €
F-UPT-171-295	Telescopic guide handle 171-295 mm	13,60 €
F-UPU-25	Universal telescopic guide handle 25 (50-60 mm)	1,00 €
F-UPU-35	Universal telescopic guide handle 35 (60-70 mm)	1,10 €
F-UPU-45	Universal telescopic guide handle 45 (70-90 mm)	1,40 €
F-UPU-65	Universal telescopic guide handle 65 (90-130 mm)	1,80 €
F-WN	Drive shaft connector	18,90 €

\* - detailed table of minimum widths on p. 61.

### HANDLES MOUNTING THE HEAD RAIL

SAFETY PLATE	PACKAGE HEIGHT	h/w	2 TOP RAIL HANDLES							3 TOP RAIL HANDLES									
			600-1000	1001-1100	1101-1200	1201-1300	1301-1400	1401-1500	1501-1600	1601-1700	1701-1800	1801-1900	1901-2000	2001-2100	2101-2200	2201-2300	2301-2400	2401-2500	
200	190	600-1000	292	301	304	314	323	340	350	359	362	366	369	380	383	387	391	414	
		1001-1100	295	304	308	323	327	345	355	364	367	371	375	386	389	393	397	421	
		1101-1200	300	310	314	329	333	352	363	372	376	380	384	395	399	403	408	432	
250	200	1201-1300	303	319	323	333	337	356	367	376	381	385	389	401	405	410	414	439	
		1301-1400	306	323	327	337	341	361	372	381	386	390	395	406	411	416	420	446	
		1401-1500	323	333	338	348	353	374	385	395	400	404	409	422	427	432	437	463	
	220	1501-1600	326	343	349	359	364	385	397	407	413	417	423	436	441	446	451	478	
		230	1601-1700	329	347	352	363	368	389	402	412	418	423	428	442	447	452	458	485
			1701-1800	334	353	358	369	375	397	410	420	426	432	438	451	457	463	469	497
300	250	1801-1900	337	356	362	373	379	401	414	425	431	437	443	457	463	469	475	503	
		1901-2000	343	362	368	380	385	408	422	434	440	446	452	467	473	480	486	515	
		2001-2100	352	372	379	390	397	421	435	446	453	460	467	481	489	495	502	532	
	260	2101-2200	355	376	383	395	401	425	440	452	459	465	472	488	494	502	508	539	
		270	2201-2300	361	382	389	401	408	433	448	461	467	474	482	498	505	513	519	550
			2301-2400	364	386	393	406	412	437	453	466	473	480	487	504	511	519	526	558
	280	2401-2500	374	397	405	417	425	451	467	480	487	495	503	520	528	536	544	576	
		2501-2600	386	408	416	429	456	464	481	494	502	510	518	546	554	582	591	605	
		2601-2700	389	412	420	434	461	469	486	499	508	516	524	553	561	589	598	612	
340	300	2701-2800	394	418	427	441	468	477	494	508	516	525	533	563	572	601	610	625	
		310	2801-2900	398	422	430	445	473	481	499	513	522	531	540	569	578	608	617	632
			2901-3000	403	428	437	451	479	489	507	521	531	540	549	580	589	619	629	644
	320	3001-3100	414	439	449	464	493	503	531	546	556	566	576	596	606	637	647	663	
		3101-3200	418	443	453	468	498	507	536	552	562	572	582	603	613	645	655	671	
		3201-3300	423	449	459	475	505	515	545	561	571	582	592	613	624	656	667	683	
370	340	3301-3400	427	453	464	479	510	520	550	566	577	588	598	620	631	663	674	691	
		3401-3500	436	463	474	490	520	531	562	579	590	600	611	633	644	678	688	705	
	350	3501-3600	476	487	498	537	548	559	581	598	610	621	632	679	690	702	714	731	
		370	3601-3700	480	491	503	542	553	565	587	604	616	627	639	685	697	709	721	739
380	3701-3800		486	497	509	549	561	573	595	613	625	637	649	697	709	721	734	747	
	3801-3900		489	501	513	554	565	578	601	618	630	643	655	703	716	728	741	754	
440	400	3901-4000	493	505	518	558	570	582	606	624	636	649	661	710	723	735	743	762	
		410	4001-4100	508	521	534	576	589	602	625	644	658	671	684	734	747	756	770	834
			4101-4200	512	525	538	580	593	606	631	650	664	677	690	741	755	763	777	842
	430	4201-4300	518	531	545	588	602	615	640	659	673	687	701	752	762	776	835	855	
		440	4301-4400	522	535	549	593	606	620	645	665	679	693	707	755	769	828	843	863
			4401-4500	533	547	560	605	618	632	658	678	692	707	720	769	782	843	858	878
	480	440	4501-4600	549	563	578	623	638	652	679	700	715	730	740	795	856	871	886	907
			4601-4700	553	568	582	628	643	658	685	706	721	731	746	847	863	878	894	915
		450	4701-4800	558	574	589	636	651	666	694	715	731	742	802	859	875	891	906	928
			4801-4900	563	578	594	640	656	671	699	721	732	748	809	866	882	898	914	936
4901-5000	567	582	598	645	661	677	705	726	738	754	815	873	889	905	922	944			

The heights of packages concern the 180° rotation.

## EXTRA CHARGE

SYMBOL	NAME	PRICE
F-FBR-010	Guide adapter for external blind	17,80 €/m
F-FBR-020	Guide adapter for external blind with a spacer	22,10 €/m
F-FBR-030	Guide for external blind for flush-mounted installation	21,40 €/m
F-FBR-040	Guide for external blind for flush-mounted installation with a spacer	24,00 €/m
F-RSC-340	Insert guide for external blinds	4,00 €/m
F-FBD-010	Bottom plug of the F-FBR-010 guide	0,80 €/Pair
F-FBD-020	Bottom plug of the F-FBR-020 guide	0,80 €/Pair
F-FBD-030	Bottom plug of the F-FBR-030 guide	0,50 €/Pair
F-FBD-040	Bottom plug of the F-FBR-040 guide	0,60 €/Pair
F-FBD-011	Bottom alu plug of the F-FBR-010 guide	7,70 €/Pair
F-FBD-021	Bottom alu plug of the F-FBR-020 guide	7,70 €/Pair
F-FBD-031	Bottom alu plug of the F-FBR-030 guide	8,50 €/Pair
F-FBD-041	Bottom alu plug of the F-FBR-040 guide	8,50 €/Pair
F-FBD-071	Bottom alu plug of the F-FBR-070 double guide	6,30 €/Pc
F-FBD-081	Bottom alu plug of the F-FBR-080 double guide	7,30 €/Pc

The price given in the table does not include safety plates.

Price list of safety plates is available on p. 52-55.

Price list of additional components for external blinds is available on p. 56.

## EXTRA CHARGES FOR MOTORS

NAME	6 Nm	9 Nm	10 Nm	18 Nm	20 Nm
AM55 / VB55	VB55-6/22EL Included in the price	-	AM55-10/35-EL Included in the price	-	-
ELERO SOFT	JA 06 SOFT Included in the price	JA 09 SOFT Included in the price	-	-	JA 20 DK Included in the price
SOMFY WT	J406 6/24 WT	-	J410 10/24 WT	J418 18/24 WT	-
	39,40€	-	40,50€	62,90€	-
SOMFY WT PROTECT	J406 6/24 WT PROTECT	-	J410 10/24 WT PROTECT	J418 18/24 WT PROTECT	-
	74,70€	-	51,90€	82€	-
ELERO COMFORT	JA 06 COMFORT-968	JA 09 COMFORT-968	-	-	-
	131,70€	157,40€	-	-	-
SOMFY RTS	J406 6/24 RTS	-	J410 10/24 RTS	J418 18/24 RTS	-
	171,70€	-	183,20€	208,90€	-
SOMFY IO PROTECT	J406 6/24 IO PROTECT	-	J410 10/24 IO PROTECT	J418 18/24 IO PROTECT	-
	171,70€	-	183,20€	208,90€	-
ELERO NHK	-	JA 09 NHK ZESTAW*	-	-	-
	-	878,10€	-	-	-

\* - Product for special order

CRANK MECHANISM (set) - 20,60€

CRANK STEM EXTENSION - 14,20€/m

### HANDLES MOUNTING THE HEAD RAIL

4 TOP RAIL HANDLES									5 TOP RAIL HANDLES						6 TOP RAIL HANDLES					QUANTITY OF GUIDE HANDLES
2501-2600	2601-2700	2701-2800	2801-2900	2901-3000	3001-3100	3101-3200	3201-3300	3301-3400	3401-3500	3501-3600	3601-3700	3701-3800	3801-3900	3901-4000	4001-4100	4101-4200	4201-4300	4301-4400	4401-4500	
426	429	433	437	440	463	467	470	480	499	521	525	529	538	542	556	559	564	568	572	2 PAIRS
432	436	440	444	448	471	475	479	488	508	530	535	539	548	553	566	571	575	579	583	
444	449	453	457	462	486	490	494	504	524	548	552	557	567	572	586	590	595	600	605	3 PAIRS
452	456	460	465	469	494	498	503	513	533	557	562	567	577	582	597	602	607	611	616	
458	463	468	472	477	502	506	511	521	542	567	572	577	588	592	608	613	618	623	628	4 PAIRS
476	481	486	492	496	522	527	532	543	565	591	596	601	612	618	634	640	645	651	656	
493	497	503	509	514	550	555	561	572	595	611	617	622	634	640	656	662	668	674	680	5 PAIRS
500	505	511	516	522	558	564	570	581	604	621	627	633	645	650	668	674	680	685	692	
512	518	524	530	536	573	579	585	597	621	638	645	651	663	669	687	694	700	707	713	6 PAIRS
519	525	531	537	543	582	588	594	606	631	648	655	661	673	680	699	706	712	719	725	
532	538	544	551	557	596	603	610	622	647	666	672	680	692	699	718	725	733	740	746	7 PAIRS
559	565	572	580	586	615	622	630	642	668	687	695	702	715	722	743	750	757	764	772	
566	573	580	588	595	624	631	639	652	678	697	705	712	726	733	754	761	769	776	784	8 PAIRS
579	586	594	602	609	639	647	655	668	695	716	723	731	745	752	774	782	790	798	806	
586	594	602	610	617	648	655	663	677	705	725	734	742	756	763	786	794	802	810	818	9 PAIRS
606	614	622	630	638	670	678	686	701	729	750	759	768	782	790	813	822	831	835	843	
624	633	642	650	659	691	720	729	743	751	774	783	792	807	815	835	844	853	862	871	10 PAIRS
632	641	649	658	667	699	729	738	753	762	784	793	802	813	822	847	856	865	874	883	
645	654	663	672	682	715	745	754	769	779	802	812	817	832	842	912	922	932	942	951	11 PAIRS
653	662	672	681	691	724	754	764	779	789	808	818	828	843	853	924	934	944	954	964	
666	675	686	695	705	739	770	780	791	801	826	836	846	861	871	945	955	965	975	986	12 PAIRS
686	696	706	716	726	761	794	804	815	826	852	862	872	887	897	971	981	991	1001	1011	
694	704	714	724	735	770	803	809	826	836	862	872	882	897	907	981	991	1001	1011	1021	13 PAIRS
707	718	728	739	750	786	815	826	836	862	872	882	897	907	917	991	1001	1011	1021	1031	
714	726	737	747	753	790	824	831	841	851	877	887	897	912	922	996	1006	1016	1026	1036	14 PAIRS
730	741	752	758	769	807	836	846	856	882	892	902	912	927	937	1010	1020	1030	1040	1050	
757	768	776	810	868	907	918	930	949	961	1007	1019	1032	1051	1064	1131	1144	1157	1170		15 PAIRS
764	772	784	865	877	916	928	941	959	971	1018	1030	1043	1063	1130	1143	1157	1170			
773	786	844	880	892	932	945	958	977	990	1037	1050	1064	1138	1152	1166	1180				16 PAIRS
781	839	852	888	901	941	954	967	986	1000	1048	1115	1129	1150	1164	1193					
834	847	860	897	910	951	964	977	997	1010	1112	1127	1141	1163	1391						17 PAIRS
862	876	890	928	942	1000	1015	1029	1049	1117	1132	1147	1162	1398							
871	885	898	938	951	1010	1025	1039	1114	1129	1144	1373	1388								18 PAIRS
885	899	913	953	967	1027	1042	1111	1133	1149	1378	1394									
893	907	922	962	976	1037	1105	1121	1144	1373	1389										19 PAIRS
909	923	938	978	993	1109	1125	1141	1378	1394											
955	971	987	1029	1099	1126	1143	1374	1398												20 PAIRS
963	979	995	1092	1109	1137	1368	1385	1409												
978	994	1062	1108	1126	1369	1386	1404													21 PAIRS
986	1054	1071	1118	1349	1379	1397														
994	1063	1081	1342	1360	1389	1408														

- BLIND MOTOR 6 Nm
- BLIND MOTOR 9 Nm
- BLIND MOTOR 10 Nm
- BLIND MOTOR 20 Nm

Maximum area	16 m <sup>2</sup>
Minimum width *	560 mm
Minimum height	600 mm
Maximum width	4000 mm
Maximum height	5000 mm

## STANDARD EQUIPMENT

Wall handles	F-US-140
Top rail handles	F-USG
Cord guide	F-PL
Cord guide lower handles	F-UDPL-80
Slat rotation	90°

## EXTRA CHARGE

SYMBOL	NAME	PRICE
F-US-100-150	Adjustable wall handle 100-150 mm	5,40 €
F-US-150-200	Adjustable wall handle 150-200 mm	6,20 €
F-US-200-250	Adjustable wall handle 200-250 mm	7,10 €
F-USG-A	Automatic top rail handle	1,70 €
F-UDPL-120	Cord guide lower handle 120 mm	1,10 €
F-UDPL-150	Cord guide lower handle 150 mm	1,70 €
F-UDPP	Cord guide lower handle attached to the floor	2,80 €
F-WN	Drive shaft connector	18,90 €

\* - detailed table of minimum widths on p. 61.

## HANDLES MOUNTING THE HEAD RAIL

SAFETY PLATE	PACKAGE HEIGHT	h/w	2 TOP RAIL HANDLES								3 TOP RAIL HANDLES					
			600-1000	1001-1100	1101-1200	1201-1300	1301-1400	1401-1500	1501-1600	1601-1700	1701-1800	1801-1900	1901-2000	2001-2100	2101-2200	2201-2300
200	160	600-1000	313	322	326	324	334	350	361	369	372	377	380	392	395	399
		1001-1100	315	325	328	333	336	354	364	373	376	380	384	396	400	404
	170	1101-1200	319	329	334	339	343	361	373	381	386	390	394	406	411	415
		1201-1300	322	338	343	342	346	365	376	386	390	394	399	412	416	421
250	200	1301-1400	324	341	346	345	350	368	380	390	394	399	404	417	422	427
		1401-1500	333	344	349	349	354	373	387	396	401	406	412	426	430	436
	210	1501-1600	333	352	357	357	362	383	397	406	412	417	423	437	443	449
		1601-1700	335	354	360	360	365	387	400	411	416	422	428	442	449	454
300	220	1701-1800	340	360	366	366	372	394	409	419	426	432	438	453	460	466
		1801-1900	342	362	369	369	376	399	413	424	430	437	443	458	466	472
	230	1901-2000	347	368	374	376	382	406	421	432	439	445	453	469	476	483
		2001-2100	356	379	385	386	393	418	434	446	453	460	467	484	491	499
340	240	2101-2200	359	381	388	389	397	422	438	450	458	465	473	490	497	505
		2201-2300	364	386	394	396	404	430	446	459	467	475	482	501	508	517
	250	2301-2400	366	389	397	399	406	433	451	463	471	479	487	506	514	522
		2401-2500	368	393	401	403	412	440	458	470	479	488	496	515	524	532
370	260	2501-2600	378	402	411	414	443	452	471	484	493	501	510	541	551	582
		2601-2700	380	405	415	417	448	456	475	489	498	507	516	547	557	589
	270	2701-2800	385	411	420	424	454	464	483	497	507	516	526	558	568	601
		2801-2900	387	414	423	427	458	468	488	502	512	521	531	564	574	608
370	280	2901-3000	392	419	429	433	466	476	496	511	521	532	542	576	586	621
		3001-3100	404	431	442	446	480	491	522	538	549	560	570	594	605	641
	290	3101-3200	406	435	445	450	484	495	527	543	554	565	576	599	611	647
		3201-3300	411	440	451	456	492	503	536	552	564	575	587	611	623	660
370	300	3301-3400	414	443	454	460	496	507	540	557	569	581	592	617	629	667
		3401-3500	415	445	456	462	498	509	543	560	572	585	597	621	634	672
	310	3501-3600	456	469	481	515	527	539	563	581	594	607	620	673	686	699
		3601-3700	459	471	484	518	531	544	568	586	599	612	625	680	693	706
370	320	3701-3800	465	478	491	526	539	552	577	596	609	623	636	692	706	715
		3801-3900	468	481	494	530	543	556	582	601	614	628	642	699	713	721
	330	3901-4000	470	484	498	534	547	561	586	605	620	633	647	705	714	729
		4001-4100	486	500	515	553	567	581	608	628	643	657	672	732	743	757
370	340	4101-4200	489	504	518	557	571	586	614	633	648	663	678	734	749	765
		4201-4300	495	510	525	565	580	595	623	644	659	674	690	747	763	779
	350	4301-4400	498	513	529	569	584	599	628	648	664	680	691	754	770	791
		4401-4500	499	515	531	571	587	602	631	653	668	684	695	759	780	796
370	360	4501-4600	516	532	548	591	607	624	654	676	692	704	721	788	809	826
		4601-4700	518	535	552	595	612	628	658	681	693	710	727	799	816	834
	370	4701-4800	525	542	559	604	620	637	668	691	704	721	744	812	830	848
		4801-4900	528	545	562	608	625	643	673	697	710	727	750	819	837	855
370	370	4901-5000	530	548	566	611	629	646	678	696	714	732	755	825	844	862

The cord leading prevents the slats from complete closure.

## EXTRA CHARGES FOR MOTORS

NAME	6 Nm	9 Nm	10 Nm	18 Nm	20 Nm
AM55 / VB55	VB55-6/22EL Included in the price	-	AM55-10/35-EL Included in the price	-	-
ELERO SOFT	JA 06 SOFT Included in the price	JA 09 SOFT Included in the price	-	-	JA 20 DK Included in the price
SOMFY WT	J406 6/24 WT 39,40 €	-	J410 10/24 WT 40,50 €	J418 18/24 WT 62,90 €	-
SOMFY WT PROTECT	J406 6/24 IO PROTECT 74,70 €	-	J410 10/24 WT PROTECT 51,90 €	J418 18/24 WT PROTECT 82 €	-
ELERO COMFORT	JA 06 COMFORT 868 131,70 €	JA 09 COMFORT 868 157,40 €	-	-	-
SOMFY RTS	J406 6/24 RTS 171,70 €	-	J410 10/24 RTS 183,20 €	J418 18/24 RTS 208,90 €	-
SOMFY IO PROTECT	J406 6/24 IO PROTECT 171,70 €	-	J410 10/24 IO PROTECT 183,20 €	J418 18/24 IO PROTECT 208,90 €	-
ELERO NHK	-	JA 09 NHK ZESTAW* 878,10 €	-	-	-

\* - Product for special order

CRANK MECHANISM (set) - 20,60€

CRANK STEM EXTENSION - 14,20€/m

The price given in the table does not include safety plates.

Price list of safety plates is available on p. 52-55.

Price list of additional components for external blinds is available on p. 56.

### HANDLES MOUNTING THE HEAD RAIL

		4 TOP RAIL HANDLES									5 TOP RAIL HANDLES					
2301-2400	2401-2500	2501-2600	2601-2700	2701-2800	2801-2900	2901-3000	3001-3100	3101-3200	3201-3300	3301-3400	3401-3500	3501-3600	3601-3700	3701-3800	3801-3900	3901-4000
403	419	437	441	445	449	453	477	481	485	488	512	536	540	545	548	553
408	425	443	447	451	456	460	484	488	493	496	520	545	550	554	558	563
420	438	456	462	466	470	475	501	505	510	514	539	565	570	575	579	584
426	444	464	468	473	478	483	508	514	518	523	548	575	580	585	590	595
432	450	470	476	480	486	491	516	521	527	531	558	585	591	595	601	606
441	461	481	487	493	498	503	531	536	542	547	574	603	609	615	620	626
454	475	496	502	508	514	520	558	565	570	576	605	623	630	636	641	648
460	482	503	509	515	521	527	567	573	580	585	615	634	640	646	652	659
473	495	517	524	530	537	543	584	590	597	604	634	654	661	667	674	681
478	501	524	531	538	544	551	592	599	606	612	644	664	671	679	685	692
490	514	537	544	552	558	566	608	616	623	630	663	683	691	699	706	713
506	531	567	575	582	591	598	629	637	645	652	686	707	715	723	731	739
512	538	575	583	591	598	606	637	646	654	661	696	718	726	734	742	750
525	552	589	597	606	614	622	655	663	672	680	716	738	747	756	764	773
531	558	595	604	613	621	630	663	672	681	689	725	748	757	766	774	783
541	569	609	617	626	635	644	679	688	697	706	743	768	777	786	795	805
591	600	627	637	646	656	665	700	733	743	752	768	792	802	812	816	826
598	607	635	644	654	664	674	709	743	752	762	778	803	808	819	828	838
611	620	649	659	669	680	690	726	761	771	781	797	819	829	839	850	860
618	628	657	667	678	688	698	735	770	781	785	802	829	840	851	861	877
632	641	671	682	693	704	715	752	783	794	805	822	850	861	878	889	900
652	662	693	705	716	727	738	771	809	821	832	849	879	895	907	918	930
659	669	700	712	724	736	742	780	819	831	842	865	894	906	918	930	942
672	683	715	727	739	746	758	798	837	850	866	885	915	928	940	952	965
679	691	723	730	743	755	767	807	847	865	877	896	926	939	952	964	977
685	697	725	737	749	762	775	815	861	874	887	905	936	949	962	975	988
712	725	754	768	781	823	841	884	897	910	924	943	994	1 008	1 022	1 036	1 050
714	732	762	775	789	836	850	892	907	921	934	953	1 005	1 019	1 034	1 048	1 123
728	747	777	791	810	854	868	911	926	940	954	974	1 028	1 042	1 057	1 133	1 149
735	754	785	804	818	863	877	921	936	950	964	985	1 039	1 114	1 130	1 136	1 152
743	761	798	812	827	872	886	931	946	961	975	996	1 110	1 127	1 132	1 149	1 190
772	792	830	845	860	908	923	987	1 003	1 018	1 034	1 117	1 133	1 140	1 157	1 198	
780	800	838	853	869	917	932	997	1 013	1 029	1 105	1 118	1 135	1 177	1 194		
799	814	853	870	885	935	950	1 016	1 033	1 110	1 127	1 141	1 183	1 201			
807	822	861	878	894	943	960	1 027	1 103	1 111	1 129	1 177	1 195				
812	828	868	885	901	951	968	1 096	1 104	1 122	1 164	1 189					
843	860	919	937	954	1 008	1 086	1 106	1 124	1 167	1 186						
851	868	927	946	963	1 077	1 086	1 117	1 160	1 179	1 198						
865	883	944	963	1 038	1 087	1 106	1 161	1 181	1 201							
873	891	952	1 028	1 048	1 097	1 141	1 173	1 193								
880	897	960	1 037	1 047	1 131	1 152	1 183	1 204								

- BLIND MOTOR 6 Nm
- BLIND MOTOR 9 Nm
- BLIND MOTOR 10 Nm
- BLIND MOTOR 20 Nm

## EXTRA CHARGE

Maximum area	16 m <sup>2</sup>
Minimum width (F-PP guides) *	560 mm
Minimum width (F-FBR guides) *	574mm
Minimum height	600 mm
Maximum width	4500 mm
Maximum height	5000 mm

### STANDARD EQUIPMENT

Wall handles	F-US-140
Top rail handles	F-USG
Guides	F-PP-20
Aluminium guide handles	F-UPP-50-70
Slat rotation	90°

SYMBOL	NAME	PRICE
F-US-100-150	Adjustable wall handle 100-150 mm	5,40 €
F-US-150-200	Adjustable wall handle 150-200 mm	6,20 €
F-US-200-250	Adjustable wall handle 200-250 mm	7,10 €
F-USG-A	Automatic top rail handle	1,70 €
F-UPP-71-100	Straight guide handle 71-100 mm	0,90 €
F-UPP-101-145	Straight guide handle 101-145 mm	1,90 €
F-UPT-50-70	Telescopic guide handle 50-70 mm	6,60 €
F-UPT-71-105	Telescopic guide handle 71-105 mm	8,00 €
F-UPT-106-170	Telescopic guide handle 106-170 mm	11,00 €
F-UPT-171-295	Telescopic guide handle 171-295 mm	13,60 €
F-UPU-25	Universal telescopic guide handle 25 (50-60 mm)	1,00 €
F-UPU-35	Universal telescopic guide handle 35 (60-70 mm)	1,10 €
F-UPU-45	Universal telescopic guide handle 45 (70-90 mm)	1,40 €
F-UPU-65	Universal telescopic guide handle 65 (90-130 mm)	1,80 €
F-WN	Drive shaft connector	18,90 €

\* - detailed table of minimum widths on p. 61.

### HANDLES MOUNTING THE HEAD RAIL

SAFETY PLATE	PACKAGE HEIGHT	h/w	2 TOP RAIL HANDLES							3 TOP RAIL HANDLES									
			600-1000	1001-1100	1101-1200	1201-1300	1301-1400	1401-1500	1501-1600	1601-1700	1701-1800	1801-1900	1901-2000	2001-2100	2101-2200	2201-2300	2301-2400	2401-2500	
200	160	600-1000	311	320	324	327	337	354	364	373	377	381	384	395	399	403	406	430	
		1001-1100	317	327	331	341	346	364	375	384	388	392	396	408	412	417	421	445	
	180	1101-1200	322	332	336	346	351	370	381	391	395	399	403	416	420	425	429	454	
		1201-1300	326	342	347	351	356	375	387	397	402	406	410	423	428	432	438	463	
		1301-1400	329	347	352	356	361	381	393	403	408	413	417	431	436	441	445	472	
		1401-1500	340	351	356	361	366	387	399	410	414	420	425	438	444	449	454	481	
250	200	1501-1600	353	372	377	383	389	411	424	435	441	446	452	467	473	478	484	513	
		1601-1700	357	377	382	388	394	417	431	442	448	453	459	475	480	487	492	522	
	210	1701-1800	361	381	387	393	399	423	437	448	455	461	467	482	489	495	501	531	
		1801-1900	365	386	392	398	404	429	443	455	461	468	474	490	497	503	509	540	
	220	1901-2000	372	393	400	407	413	439	454	466	473	480	487	503	510	517	524	556	
		2001-2100	384	405	412	419	427	453	469	482	489	496	503	521	528	535	543	577	
	230	2101-2200	388	410	418	425	432	459	476	489	496	503	511	529	537	544	552	586	
		2201-2300	392	415	423	430	438	465	482	495	503	511	518	537	544	553	560	595	
	240	2301-2400	399	423	430	439	446	476	493	506	515	523	531	550	558	567	576	611	
		2401-2500	403	427	435	444	452	482	500	513	522	530	539	558	566	575	584	621	
300	250	2501-2600	422	447	455	464	495	504	523	537	546	555	564	595	604	638	647	662	
		2601-2700	427	452	461	469	502	511	530	544	553	563	571	603	612	647	657	672	
	260	2701-2800	433	459	469	478	511	521	541	556	565	575	584	618	628	663	673	689	
		2801-2900	438	465	474	483	517	527	547	563	572	582	592	625	636	672	682	699	
	270	2901-3000	442	469	479	489	524	534	554	569	579	590	600	634	644	681	692	708	
		3001-3100	455	483	493	504	540	550	582	599	609	620	631	654	665	704	714	732	
	280	3101-3200	460	488	498	509	546	556	589	606	617	628	639	662	674	713	724	742	
		3201-3300	467	496	507	518	556	567	601	618	629	641	653	677	689	729	741	759	
	290	3301-3400	471	501	512	524	562	573	607	625	637	649	661	685	697	739	751	769	
		3401-3500	476	506	517	529	568	580	614	632	644	656	669	694	706	748	761	779	
	340	300	3501-3600	525	537	550	592	604	616	641	659	672	684	697	754	767	779	793	811
			3601-3700	533	545	558	602	615	628	652	671	685	698	711	769	783	796	805	829
310		3701-3800	537	551	564	608	621	634	659	679	692	706	719	778	792	801	814	839	
		3801-3900	542	556	569	614	627	641	666	686	699	713	727	787	801	810	824	849	
320		3901-4000	547	560	574	620	633	647	673	693	707	721	735	796	806	819	834	860	
		4001-4100	565	579	594	642	656	670	698	719	734	748	763	827	837	852	867	934	
330		4101-4200	570	585	599	648	663	678	705	726	741	756	771	832	847	862	877	945	
		4201-4300	575	590	605	654	669	684	712	734	749	764	780	841	857	872	933	955	
370		340	4301-4400	580	595	610	660	676	691	719	741	757	772	783	850	866	927	943	965
			4401-4500	588	604	620	671	686	702	731	754	770	786	797	866	882	944	960	983
	350	4501-4600	611	628	644	697	714	730	760	783	800	812	829	900	962	979	997	1020	
		4601-4700	617	633	650	704	721	737	768	791	803	820	837	954	972	989	1006	1030	
	360	4701-4800	622	639	656	710	727	744	775	798	811	829	891	964	982	999	1017	1041	
		4801-4900	627	644	661	716	733	751	782	806	819	837	900	973	991	1009	1027	1052	
	370	4901-5000	635	652	670	727	745	763	795	814	833	850	914	989	1008	1027	1045	1070	

## EXTRA CHARGE

SYMBOL	NAME	PRICE
F-FBR-010	Guide adapter for external blind	17,80 €/m
F-FBR-020	Guide adapter for external blind with a spacer	22,10 €/m
F-FBR-030	Guide for external blind for flush-mounted installation	21,40 €/m
F-FBR-040	Guide for external blind for flush-mounted installation with a spacer	24,00 €/m
F-RSC-340	Insert guide for external blinds	4,00 €/m
F-FBD-010	Bottom plug of the F-FBR-010 guide	0,80 €/Pair
F-FBD-020	Bottom plug of the F-FBR-020 guide	0,80 €/Pair
F-FBD-030	Bottom plug of the F-FBR-030 guide	0,50 €/Pair
F-FBD-040	Bottom plug of the F-FBR-040 guide	0,60 €/Pair
F-FBD-011	Bottom alu plug of the F-FBR-010 guide	7,70 €/Pair
F-FBD-021	Bottom alu plug of the F-FBR-020 guide	7,70 €/Pair
F-FBD-031	Bottom alu plug of the F-FBR-030 guide	8,50 €/Pair
F-FBD-041	Bottom alu plug of the F-FBR-040 guide	8,50 €/Pair
F-FBD-071	Bottom alu plug of the F-FBR-070 double guide	6,30 €/Pc
F-FBD-081	Bottom alu plug of the F-FBR-080 double guide	7,30 €/Pc

The price given in the table does not include safety plates.

Price list of safety plates is available on p. 52-55.

Price list of additional components for external blinds is available on p. 56.

## EXTRA CHARGES FOR MOTORS

NAME	6 Nm	9 Nm	10 Nm	18 Nm	20 Nm
AM55 / VB55	VB55-6/22EL Included in the price	-	AM55-10/35-EL Included in the price	-	-
ELERO SOFT	JA 06 SOFT Included in the price	JA 09 SOFT Included in the price	-	-	JA 20 DK Included in the price
SOMFY WT	J406/6/24 WT	-	J410/10/24 WT	J418/18/24 WT	-
	39,40€	-	40,50€	62,90€	-
SOMFY WT PROTECT	J406/6/24 WT PROTECT	-	J410/10/24 WT PROTECT	J418/18/24 WT PROTECT	-
	74,70€	-	51,90€	82€	-
ELERO COMFORT	JA 06 COMFORT-868	JA 09 COMFORT-868	-	-	-
	131,70€	157,40€	-	-	-
SOMFY RTS	J406/6/24 RTS	-	J410/10/24 RTS	J418/18/24 RTS	-
	171,70€	-	183,20€	208,90€	-
SOMFY IO PROTECT	J406/6/24 IO PROTECT	-	J410/10/24 IO PROTECT	J418/18/24 IO PROTECT	-
	171,70€	-	183,20€	208,90€	-
ELERO NHK	-	JA 09 NHK ZESTAW*	-	-	-
	-	878,10€	-	-	-

\* - Product for special order

CRANK MECHANISM (set) - 20,60€

CRANK STEM EXTENSION - 14,20€/m

## HANDLES MOUNTING THE HEAD RAIL

4 TOP RAIL HANDLES									5 TOP RAIL HANDLES						6 TOP RAIL HANDLES					QUANTITY OF GUIDE HANDLES
2501-2600	2601-2700	2701-2800	2801-2900	2901-3000	3001-3100	3101-3200	3201-3300	3301-3400	3401-3500	3501-3600	3601-3700	3701-3800	3801-3900	3901-4000	4001-4100	4101-4200	4201-4300	4301-4400	4401-4500	
442	445	449	454	457	481	485	489	499	517	541	545	550	559	564	578	583	587	591	595	2 PAIRS
458	462	467	471	475	500	505	509	519	539	565	569	574	584	589	605	609	614	619	623	
467	472	477	481	486	511	516	520	531	552	578	582	588	598	603	619	624	629	634	640	3 PAIRS
477	482	486	491	496	522	527	532	542	564	591	596	601	612	617	634	639	644	650	655	
486	491	496	502	506	533	538	543	554	576	604	609	614	626	631	648	654	660	665	671	4 PAIRS
495	501	506	512	517	544	549	554	565	588	616	622	628	639	645	663	669	675	681	687	
529	535	541	547	553	592	597	604	616	641	660	666	672	685	691	710	717	723	730	736	5 PAIRS
539	545	551	557	563	603	609	616	628	654	673	680	686	698	705	725	732	739	746	752	
548	555	561	567	573	614	621	628	640	667	686	693	700	713	720	740	747	754	761	768	6 PAIRS
558	564	571	577	585	625	632	640	652	680	699	706	714	727	734	755	762	770	777	784	
574	581	589	596	603	645	653	660	673	702	723	731	738	752	760	782	790	798	805	813	7 PAIRS
607	615	622	630	638	669	677	685	699	729	750	758	767	781	789	812	820	828	837	845	
617	625	633	641	648	680	688	697	711	742	764	772	781	795	803	827	836	844	853	861	8 PAIRS
627	635	643	651	659	692	700	709	723	755	777	786	795	809	818	842	851	860	869	877	
644	653	662	670	679	712	721	730	745	778	802	811	820	835	844	870	879	889	893	903	9 PAIRS
654	663	672	681	690	724	733	742	758	791	815	825	835	850	859	885	890	900	909	919	
684	694	703	713	722	757	792	802	817	827	852	863	872	884	894	921	931	941	951	962	10 PAIRS
694	704	714	724	734	769	805	814	830	840	866	872	882	898	909	937	947	957	1013	1023	
712	723	733	743	753	789	827	837	854	864	887	897	908	925	935	1010	1021	1032	1042	1053	11 PAIRS
722	733	744	754	765	801	839	850	862	872	900	911	923	939	996	1025	1036	1048	1059	1070	
733	743	755	765	776	813	847	857	875	886	914	925	982	999	1011	1041	1052	1064	1076	1087	12 PAIRS
757	768	780	791	802	835	876	887	905	916	946	1003	1014	1033	1045	1095	1107	1119	1131	1144	
767	779	790	802	808	847	888	900	918	975	1005	1017	1029	1048	1060	1111	1123	1136	1148	1161	13 PAIRS
785	797	810	816	829	869	911	923	987	999	1030	1043	1056	1075	1087	1140	1153	1166	1179	1192	
796	803	816	828	840	880	924	982	1000	1013	1044	1057	1070	1090	1102	1156	1169	1183	1196	1210	14 PAIRS
801	814	826	839	852	892	982	994	1014	1027	1058	1072	1085	1104	1118	1172	1186	1200	1213	1307	
835	848	862	906	965	1007	1021	1034	1054	1068	1120	1134	1148	1169	1183	1260	1275	1290	1295	15 PAIRS	
854	868	882	973	986	1030	1044	1058	1078	1092	1146	1161	1176	1197	1275	1291	1296	1312			
864	879	937	984	998	1042	1057	1071	1092	1106	1161	1176	1191	1276	1292	1298	1314				16 PAIRS
875	935	949	996	1011	1055	1070	1084	1105	1120	1176	1253	1269	1283	1299	1542					
931	945	960	1008	1023	1068	1082	1098	1119	1133	1253	1269	1276	1299	1543						17 PAIRS
967	982	997	1048	1064	1130	1145	1162	1184	1264	1281	1288	1305	1556							
977	993	1009	1060	1076	1143	1159	1175	1261	1269	1286	1530	1548								18 PAIRS
988	1004	1020	1073	1089	1156	1173	1252	1276	1284	1529	1547									
999	1015	1031	1085	1101	1169	1248	1256	1282	1526	1545										19 PAIRS
1018	1035	1052	1106	1123	1255	1264	1283	1535	1554											
1075	1092	1110	1168	1248	1269	1287	1533	1559												20 PAIRS
1086	1104	1122	1243	1252	1283	1528	1548	1575												
1097	1116	1194	1247	1266	1523	1543	1563													21 PAIRS
1108	1186	1206	1260	1506	1537	1558														
1128	1207	1218	1509	1530	1563	1587														

- BLIND MOTOR 6 Nm
- BLIND MOTOR 9 Nm
- BLIND MOTOR 10 Nm
- BLIND MOTOR 20 Nm

**EXTRA CHARGE**

Maximum area	16 m <sup>2</sup>
Minimum width (F-FBR guides) *****	574 mm
Minimum height	600 mm
Maximum width	4500 mm
Maximum height	5000 mm
Max. height external blind with mosquito net	2500 mm
Min. width external blind with mosquito net with the use of breake	670 mm
Maximum width of mosquito net	1800 mm
Minimum width of mosquito net	605 mm
Maximum area of mosquito net	4,5m <sup>2</sup>
Maximum area (Crank mechanism)	9 m <sup>2</sup>
Minimum width (Crank mechanism)	520 mm

**STANDARD EQUIPMENT**

Top rail handles	F-USG
Guides	F-FBR
Slat rotation	90°/180°
Bracket for the box ZF3000-BX outer cover (box over 150cm wide)	
Box insulation (type B) - according to the customer's wish	

NAME	PRICE
Box enlargement	5%
Varnishing the entire box	10%
Varnishing the box in RAL colors **, ****	30%
Guides with an offset ***	10%
Veneering guides ****	8%
Varnishing guides in RAL colors **, ****	20%
Automatic top rail handle F-USG-A	1,70 € / pc
Bracket for the box ZF3000-BX outer cover (box up to 150 cm wide)	8,00 € / pc
Wall mounting bracket	5,00 € / pc
Rolled mosquito-net	103,00 € / pc
Pleated mosquito-net	p. 51
Preparation for the mosquito net	8,70 € / pc
F-FBD-011 / 021 Untere Alu-Endkappe der Führungsschiene F-FBR-010 / 020	7,70 € / Pair
F-FBD-031 / 041 Untere Alu-Endkappe der Führungsschiene F-FBR-030 / 040	8,50 € / Pair
F-FBD-071 Untere Alu-Endkappe der DF-Schiene F-FBR-070	6,30 € / pc
F-FBD-081 Untere Alu-Endkappe der DF-Schiene F-FBR-080	7,30 € / pc
F-FBD-091 Lower aluminum end cap for double guide rail F-FBR-090	7,25 € / pc
F-FBD-101 Lower aluminum end cap for double guide rail with spacer F-FBR-100	7,50 € / pc
F-UPN 60-70 60-70mm corner guide handle	0,70 € / pc
F-UPN 80-100 80-100mm corner guide handle	1,00 € / pc
F-UPNW-75-100 75-100mm internal corner guide handle	2,40 € / pc
F-UPNW-95-140 95-140mm internal corner guide handle	4,40 € / pc
F-PN Corner profile to ZF3000-BX - SET	48,00 € / m
F-PBPL Preparing the side for cable guidance BX	24,80 € / pc
F-SKN Surcharge for corner box	13,70 € / pc
F-LSBX-180 Box connector BX 180 degrees	41,50 € / pc

**HANDLES MOUNTING THE HEAD RAIL**

SAFETY PLATE	PACKAGE HEIGHT	h/w	2 TOP RAIL HANDLES								3 TOP RAIL HANDLES								
			600-1000	1001-1100	1101-1200	1201-1300	1301-1400	1401-1500	1501-1600	1601-1700	1701-1800	1801-1900	1901-2000	2001-2100	2101-2200	2201-2300	2301-2400	2401-2500	
250	200	600-1000	409	428	442	454	477	498	512	522	535	543	557	586	600	608	622	646	
		1001-1100	419	436	450	469	484	507	521	530	544	551	565	596	610	618	633	656	
		1101-1200	428	443	457	479	494	516	530	541	555	563	578	607	622	628	643	667	
		1201-1300	434	458	473	487	501	523	538	548	563	572	587	615	630	636	651	674	
	220	1301-1400	440	465	481	493	508	531	547	556	571	580	595	623	639	645	660	683	
		1401-1500	457	474	489	503	519	543	558	568	583	592	607	635	651	658	673	697	
		1501-1600	463	480	496	509	525	550	586	597	613	622	638	656	672	679	695	720	
	230	1601-1700	469	486	502	518	535	558	595	606	622	629	645	663	680	688	704	729	
		1701-1800	478	495	512	528	544	570	607	618	635	642	659	678	695	702	719	745	
	300	250	1801-1900	489	508	525	539	556	581	620	631	648	655	673	693	710	717	735	761
1901-2000			496	514	532	547	565	586	626	634	653	660	678	697	715	723	741	767	
260		2001-2100	514	541	559	574	593	616	645	655	673	681	699	719	737	746	764	791	
		2101-2200	519	548	566	581	599	623	653	662	681	687	706	727	746	754	772	799	
270		2201-2300	528	558	576	591	610	634	665	674	693	701	720	741	760	769	788	816	
		2301-2400	534	564	583	597	617	641	672	681	700	708	727	749	768	777	796	824	
280		2401-2500	542	572	592	611	630	656	687	697	717	726	745	767	787	797	816	845	
		2501-2600	547	590	610	618	661	669	701	711	731	740	760	797	817	846	866	877	
350		300	2601-2700	575	615	637	646	692	701	736	747	769	779	801	842	863	895	916	930
			2701-2800	584	624	646	655	702	712	747	759	781	792	814	855	877	909	931	945
	310	2801-2900	590	632	654	663	709	719	755	767	789	800	823	865	887	919	941	955	
		2901-3000	599	640	663	672	720	730	766	779	801	812	835	878	900	933	956	969	
	320	3001-3100	627	659	682	693	741	751	802	816	839	852	875	903	926	960	984	998	
		3101-3200	634	667	690	700	749	759	811	825	848	861	884	912	936	970	994	1009	
	340	3201-3300	643	677	700	711	761	771	823	838	862	875	899	927	951	986	1010	1026	
		3301-3400	650	684	708	719	769	779	831	847	871	884	908	936	961	997	1021	1036	
	350	3401-3500	657	691	716	727	777	787	840	856	880	893	917	946	971	1007	1031	1047	
		3501-3600	712	725	751	791	816	827	866	884	908	923	948	1004	1029	1041	1066	1083	
370	3601-3700	719	733	758	799	824	835	875	892	918	933	958	1014	1039	1051	1076	1094		
	3701-3800	729	743	769	810	836	847	888	905	931	947	972	1029	1055	1067	1093	1111		
380	3801-3900	736	751	777	819	845	855	896	914	940	955	981	1039	1065	1077	1103	1121		
	3901-4000	744	758	785	827	853	864	905	923	949	965	991	1049	1075	1088	1114	1132		
400	4001-4100	765	781	808	852	879	891	933	952	979	996	1023	1082	1109	1123	1150	1169		
	4101-4200	773	789	816	861	888	899	941	961	988	1005	1032	1092	1119	1134	1161	1226		
410	4201-4300	783	800	827	872	899	911	954	974	1002	1019	1047	1107	1135	1150	1177	1243		
	4301-4400	790	807	835	881	908	920	963	983	1011	1029	1056	1117	1145	1160	1233	1254		
430	4401-4500	797	815	843	888	916	928	972	992	1020	1038	1066	1127	1155	1216	1244	1265		
	4501-4600	820	839	867	915	943	956	1000	1022	1050	1070	1099	1162	1235	1252	1281	1303		
440	4601-4700	827	846	875	923	951	964	1009	1031	1060	1080	1108	1171	1245	1263	1292	1315		
	4701-4800	837	857	886	935	964	977	1022	1045	1074	1094	1123	1232	1261	1279	1308	1332		
450	4801-4900	845	865	894	943	972	985	1031	1054	1083	1103	1178	1242	1272	1290	1319	1343		
	4901-5000	852	872	902	951	981	994	1040	1063	1092	1113	1188	1253	1282	1300	1331	1354		

The heights of packages concern the 180° rotation.  
 With C80 AiB over 340 cm high, the package will protrude beyond the box.

## EXTRA CHARGES FOR MOTORS

NAME	6 Nm	9 Nm	10 Nm	18 Nm	20 Nm
AM55 / VB55	VB55-6/22EL Included in the price	-	AM55-10/35-EL Included in the price	-	-
ELERO SOFT	JA 06 SOFT Included in the price	JA 09 SOFT Included in the price	-	-	JA 20 DK Included in the price
SOMFY WT	J406 6/24WT 39,40 €	-	J410 10/24WT 40,50 €	J418 18/24WT 62,90 €	-
SOMFY WT PROTECT	J406 6/24WT PROTECT 74,70 €	-	J410 10/24WT PROTECT 51,90 €	J418 18/24WT PROTECT 82 €	-
ELERO COMFORT	JA 06 COMFORT-868 131,70 €	JA 09 COMFORT-868 157,40 €	-	-	-
SOMFY RTS	J406 6/24RTS 171,70 €	-	J410 10/24RTS 183,20 €	J418 18/24RTS 208,90 €	-
SOMFY IO PROTECT	J406 6/24IO PROTECT 171,70 €	-	J410 10/24IO PROTECT 183,20 €	J418 18/24IO PROTECT 208,90 €	-
ELERO NHK	-	JA 09 NHK ZESTAW* 878,10 €	-	-	-

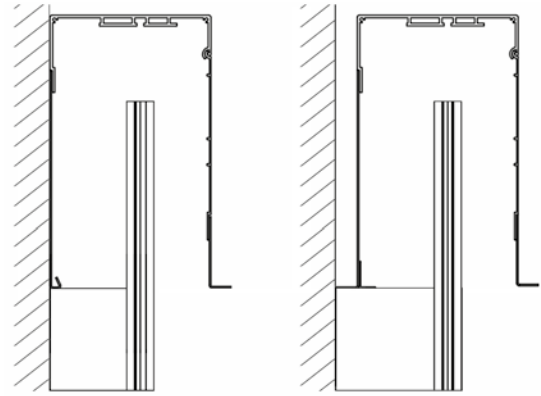

**TYP A** - Flush-mount-  
ed box. Dedicated  
F-FBR-030 guides.

**TYP B** - Flush-mounted  
box with an offset. Dedicat-  
ed F-FBR-040 guides.

- \* - Product for special order
  - \*\* - colors other than the standard colours of the ZF3000 external blinds.  
In the case of little saleable RAL colors - individual valuation.
  - \*\*\* - surcharge applies only to type A.
  - \*\*\*\* - completion date up to 21 business days.
  - \*\*\*\*\* - detailed table of minimum widths on p. 61.
- CRANK MECHANISM (set) - 20,60 €  
CRANK STEM EXTENSION - 14,20 €/m

### HANDLES MOUNTING THE HEAD RAIL

4 TOP RAIL HANDLES								5 TOP RAIL HANDLES							6 TOP RAIL HANDLES					
2501-2600	2601-2700	2701-2800	2801-2900	2901-3000	3001-3100	3101-3200	3201-3300	3301-3400	3401-3500	3501-3600	3601-3700	3701-3800	3801-3900	3901-4000	4001-4100	4101-4200	4201-4300	4301-4400	4401-4500	
672	681	695	704	718	748	762	771	787	812	853	863	877	888	902	927	941	951	965	979	991
682	691	705	713	728	759	773	782	799	823	865	876	890	901	915	941	956	965	979	991	
694	700	715	722	737	768	783	790	807	830	874	883	898	909	923	947	963	971	986	998	
701	708	723	730	745	776	792	798	816	839	885	894	909	919	934	959	974	983	998	1010	
711	718	734	741	756	788	803	810	827	851	898	906	921	932	947	973	988	997	1012	1025	
725	733	749	756	772	804	820	827	845	869	916	925	941	952	968	993	1009	1019	1034	1047	
749	756	772	781	797	845	861	869	887	913	945	955	971	982	998	1025	1041	1051	1067	1080	
759	767	783	792	808	857	873	882	900	926	959	969	986	997	1014	1040	1057	1067	1084	1096	
776	784	801	809	826	875	892	901	921	947	981	991	1008	1020	1037	1065	1082	1092	1109	1122	
792	801	818	826	844	895	912	921	941	968	1003	1013	1030	1042	1060	1089	1106	1117	1134	1149	
800	807	825	834	852	904	922	930	951	978	1014	1025	1042	1054	1072	1102	1120	1131	1149	1163	
839	849	867	877	895	932	951	960	980	1009	1045	1056	1074	1088	1106	1137	1155	1166	1184	1199	
848	858	876	886	904	942	961	970	991	1019	1057	1067	1086	1099	1117	1149	1167	1179	1197	1212	
865	875	894	904	923	961	980	990	1012	1040	1078	1090	1108	1122	1141	1173	1192	1204	1223	1238	
874	884	903	913	932	971	990	1000	1022	1051	1090	1101	1120	1133	1152	1185	1204	1216	1235	1251	
896	906	926	936	956	995	1015	1025	1047	1078	1116	1128	1148	1162	1182	1214	1234	1246	1267	1283	
914	924	944	955	975	1011	1055	1066	1088	1099	1140	1152	1172	1186	1206	1237	1257	1270	1290	1306	
969	981	1003	1015	1037	1076	1122	1135	1159	1172	1216	1230	1252	1267	1290	1324	1346	1359	1381	1399	
985	997	1019	1032	1054	1094	1141	1153	1178	1192	1236	1251	1273	1289	1312	1345	1367	1382	1450	1469	
995	1008	1031	1043	1066	1106	1153	1166	1191	1204	1249	1264	1287	1302	1324	1404	1427	1442	1465	1484	
1011	1024	1047	1060	1083	1123	1171	1185	1210	1223	1270	1283	1306	1323	1391	1427	1450	1465	1488	1508	
1040	1054	1078	1091	1115	1156	1205	1219	1245	1260	1306	1320	1389	1407	1430	1546	1570	1588	1612	1634	
1051	1065	1088	1102	1126	1168	1218	1232	1257	1272	1320	1379	1403	1421	1445	1561	1585	1604	1628	1650	
1068	1082	1106	1121	1145	1188	1238	1252	1279	1339	1387	1402	1426	1445	1469	1587	1612	1631	1655	1678	
1080	1093	1118	1132	1157	1200	1251	1265	1337	1352	1400	1416	1440	1459	1483	1602	1627	1647	1672	1694	
1091	1104	1129	1144	1169	1212	1263	1322	1349	1365	1414	1429	1454	1473	1498	1618	1643	1663	1688	1854	
1127	1142	1167	1210	1235	1281	1351	1367	1394	1411	1534	1553	1579	1602	1627	1727	1752	1775	1801		
1139	1153	1179	1222	1293	1339	1364	1380	1407	1424	1549	1568	1594	1617	1722	1743	1769	1792			
1156	1171	1197	1286	1312	1359	1385	1400	1428	1446	1572	1592	1618	1722	1749	1769	1796				
1168	1182	1254	1298	1324	1372	1398	1413	1441	1459	1586	1685	1712	1738	1765	1843					
1179	1238	1265	1310	1336	1384	1410	1426	1455	1473	1677	1701	1727	1754	1835						
1262	1278	1304	1351	1379	1499	1526	1546	1575	1674	1701	1726	1753	1834							
1273	1289	1316	1364	1391	1512	1540	1559	1664	1689	1716	1795	1822								
1291	1307	1334	1383	1410	1533	1561	1657	1687	1713	1793	2021									
1303	1318	1346	1395	1423	1547	1648	1672	1702	1780	2010										
1314	1329	1358	1407	1435	1633	1662	1686	1768	1997											
1417	1437	1466	1520	1619	1655	1684	1760	1994												
1429	1450	1478	1603	1632	1669	1748	1977	2009												
1447	1469	1567	1624	1654	1741	1972	2000													
1459	1550	1580	1638	1716	1957	1987														
1472	1562	1593	1700	1932	1971	2002														

- BLIND MOTOR 6 Nm
- BLIND MOTOR 9 Nm
- BLIND MOTOR 10 Nm
- BLIND MOTOR 20 Nm

**EXTRA CHARGE**

Maximum area	16 m <sup>2</sup>
Minimum width (F-FBR guides) *****	574 mm
Minimum height	600 mm
Maximum width	4500 mm
Maximum height	5000 mm
Max. height external blind with mosquito net	2500 mm
Min. width external blind with mosquito net with the use of breake	670 mm
Maximum width of mosquito net	1800 mm
Minimum width of mosquito net	605 mm
Maximum area of mosquito net	4,5m <sup>2</sup>
Maximum area (Crank mechanism)	9 m <sup>2</sup>
Minimum width (Crank mechanism)	520 mm

**STANDARD EQUIPMENT**

Top rail handles	F-USG
Guides	F-FBR
Slat rotation	90°/180°
Bracket for the box ZF3000-BX outer cover (box over 150cm wide)	
Box insulation (type D) - according to the customer's wish	

NAME	PRICE
Box enlargement	5%
Varnishing the box in RAL colors **, ****	30%
Guides with an offset ***	10%
Veneering guides *****	8%
Varnishing guides in RAL colors **, ****	20%
Automatic top rail handle F-USG-A	1,70 € / pc
Bracket for the box ZF3000-BX outer cover (box up to 150 cm wide)	8,00 € / pc
Wall mounting bracket	5,00 € / pc
Rolled mosquito-net	103,00 € / pc
Pleated mosquito-net	p. 51
Preparation for the mosquito net	8,70 € / pc
F-FBD-011 / 021 Untere Alu-Endkappe der Führungsschiene F-FBR-010 / 020	7,70 € / Pair
F-FBD-031 / 041 Untere Alu-Endkappe der Führungsschiene F-FBR-030 / 040	8,50 € / Pair
F-FBD-071 Untere Alu-Endkappe der DF-Schiene F-FBR-070	6,30 € / pc
F-FBD-081 Untere Alu-Endkappe der DF-Schiene F-FBR-080	7,30 € / pc
F-FBD-091 Lower aluminum end cap for double guide rail F-FBR-090	7,25 € / pc
F-FBD-101 Lower aluminum end cap for double guide rail with spacer F-FBR-100	7,50 € / pc
F-UPN 60-70 60-70mm corner guide handle	0,70 € / pc
F-UPN 80-100 80-100 mm corner guide handle	1,00 € / pc
F-UPNW-75-100 75-100mm internal corner guide handle	2,40 € / pc
F-UPNW-95-140 95-140mm internal corner guide handle	4,40 € / pc
F-PN Corner profile to ZF3000-BX - SET	48,00 € / rm
F-PBPL Preparing the side for cable guidance BX	24,80 € / pc
F-SKN Surcharge for corner box	13,70 € / pc
F-LSBX-180 Box connector BX 180 degrees	41,50 € / pc

**HANDLES MOUNTING THE HEAD RAIL**

SAFETY PLATE	PACKAGE HEIGHT	h/w	2 TOP RAIL HANDLES								3 TOP RAIL HANDLES								
			600-1000	1001-1100	1101-1200	1201-1300	1301-1400	1401-1500	1501-1600	1601-1700	1701-1800	1801-1900	1901-2000	2001-2100	2101-2200	2201-2300	2301-2400	2401-2500	
250	200	600-1000	435	456	470	487	510	532	556	567	581	592	607	624	639	646	661	686	
		1001-1100	446	464	479	503	517	541	566	576	590	600	615	633	648	655	670	695	
		1101-1200	454	472	487	511	527	548	573	581	597	603	619	636	652	659	674	699	
		1201-1300	463	488	504	518	534	555	581	589	604	610	626	644	660	667	683	707	
		1301-1400	470	495	511	525	541	563	589	597	613	619	635	654	669	677	692	717	
	220	1401-1500	487	504	520	535	552	573	600	609	625	631	648	667	683	690	706	732	
		1501-1600	492	521	538	552	569	592	619	628	645	652	669	688	705	713	730	756	
		230	1601-1700	501	528	545	557	574	597	625	634	651	659	675	696	713	721	738	765
			1701-1800	509	538	555	568	585	609	638	647	665	672	690	710	728	736	754	781
			250	1801-1900	525	552	569	581	598	621	650	659	676	683	700	720	738	745	762
1901-2000	531	554		572	583	601	624	653	661	678	685	703	723	741	748	766	792		
300	260	2001-2100	547	562	579	602	619	644	673	683	701	708	726	747	765	773	791	818	
		2101-2200	553	568	586	608	626	651	681	690	708	715	734	755	773	782	799	827	
		2201-2300	563	578	597	619	638	663	693	703	722	729	747	770	788	797	816	844	
	270	2301-2400	569	585	603	626	645	670	701	710	729	737	756	779	797	805	824	853	
		2401-2500	580	607	626	639	659	685	717	726	745	754	774	796	816	825	844	874	
	280	2501-2600	594	622	641	649	693	701	733	744	764	772	791	831	850	880	900	912	
		300	2601-2700	636	665	686	695	740	748	782	794	814	823	844	886	907	938	959	971
			2701-2800	645	674	695	705	751	759	794	805	826	836	858	900	921	953	974	987
		310	2801-2900	652	682	704	713	759	768	803	814	836	846	867	910	931	963	985	998
			2901-3000	660	691	713	723	770	779	814	826	849	858	880	923	945	978	1000	1014
320	3001-3100		679	710	733	744	791	801	851	865	888	900	922	950	973	1007	1029	1044	
	3101-3200	686	718	741	752	800	809	860	874	897	909	932	960	983	1018	1040	1055		
340	3201-3300	696	729	752	763	812	821	873	888	911	924	947	975	998	1034	1057	1072		
	3301-3400	703	736	759	771	821	830	882	897	920	933	956	985	1008	1045	1068	1084		
	3401-3500	710	744	768	779	829	838	891	906	929	943	966	995	1018	1056	1079	1095		
350	3501-3600	766	779	803	844	869	880	919	935	959	974	998	1055	1079	1091	1115	1132		
	370	3601-3700	773	787	811	853	877	888	927	945	969	983	1007	1065	1089	1102	1126	1144	
3701-3800		783	798	822	865	889	901	941	958	983	998	1023	1081	1105	1118	1143	1161		
380	3801-3900	791	805	830	873	898	909	950	967	992	1008	1032	1091	1116	1129	1154	1172		
	3901-4000	799	813	838	882	907	918	958	976	1002	1017	1042	1101	1126	1140	1165	1183		
	400	4001-4100	821	837	862	908	934	946	987	1007	1032	1049	1075	1136	1161	1177	1202	1222	
4101-4200		828	845	871	916	942	955	996	1016	1042	1059	1085	1146	1172	1188	1214	1279		
410	4201-4300	839	855	882	928	955	967	1009	1030	1056	1074	1100	1162	1188	1204	1231	1297		
	4301-4400	846	863	890	937	963	976	1019	1039	1065	1084	1110	1173	1199	1216	1287	1308		
430	4401-4500	854	871	898	946	972	985	1028	1048	1075	1093	1120	1183	1210	1272	1298	1320		
	4501-4600	877	895	923	972	999	1013	1057	1079	1106	1126	1154	1219	1291	1310	1337	1359		
440	4601-4700	885	903	931	981	1008	1022	1066	1089	1116	1136	1164	1229	1302	1321	1348	1371		
	4701-4800	895	914	942	993	1021	1035	1080	1102	1130	1151	1179	1290	1319	1337	1366	1389		
450	4801-4900	902	922	951	1001	1030	1044	1089	1112	1140	1161	1235	1301	1330	1349	1377	1401		
	4901-5000	911	930	959	1010	1039	1053	1098	1121	1150	1171	1245	1312	1341	1360	1389	1412		

The heights of packages concern the 180° rotation.

With C80 CiD over 340 cm high, the package will protrude beyond the box.

## EXTRA CHARGES FOR MOTORS

NAME	6 Nm	9 Nm	10 Nm	18 Nm	20 Nm
AM55 / VB55	VB55-6/22EL Included in the price	-	AM55-10/35-EL Included in the price	-	-
ELERO SOFT	JA 06 SOFT Included in the price	JA 09 SOFT Included in the price	-	-	JA 20 DK Included in the price
SOMFY WT	J406 6/24WT 39,40€	-	J410 10/24WT 40,50€	J418 18/24WT 62,90€	-
SOMFY WT PROTECT	J406 6/24WT PROTECT 74,70€	-	J410 10/24WT PROTECT 51,90€	J418 18/24WT PROTECT 82€	-
ELERO COMFORT	JA 06 COMFORT-868 131,70€	JA 09 COMFORT-868 157,40€	-	-	-
SOMFY RTS	J406 6/24RTS 171,70€	-	J410 10/24RTS 183,20€	J418 18/24RTS 208,90€	-
SOMFY IO PROTECT	J406 6/24IO PROTECT 171,70€	-	J410 10/24IO PROTECT 183,20€	J418 18/24IO PROTECT 208,90€	-
ELERO NHK	-	JA 09 NHK ZESTAW* 878,10€	-	-	-

- \* - Product for special order
  - \*\* - colors other than the standard colours of the ZF3000 external blinds.  
In the case of little saleable RAL colors - individual valuation.
  - \*\*\* - surcharge applies only to type A.
  - \*\*\*\* - completion date up to 21 business days.
  - \*\*\*\*\* - detailed table of minimum widths on p. 61.
- CRANK MECHANISM (set) - 20,60€  
CRANK STEM EXTENSION - 14,20€/m

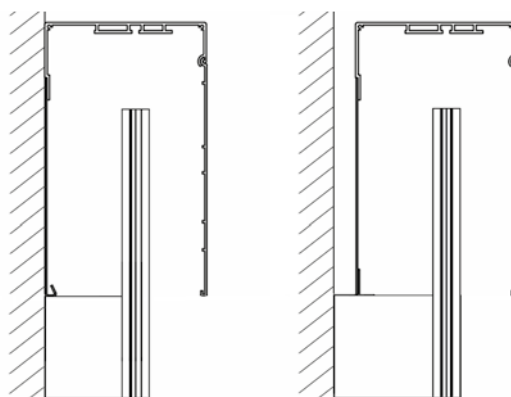

**TYP C** - Facade box.  
Dedicated F-FBR-010  
guides.

**TYP D** - Facade box  
with an offset. Dedicated  
F-FBR-020 guides.

### HANDLES MOUNTING THE HEAD RAIL

4 TOP RAIL HANDLES						5 TOP RAIL HANDLES						6 TOP RAIL HANDLES							
2501-2600	2601-2700	2701-2800	2801-2900	2901-3000	3001-3100	3101-3200	3201-3300	3301-3400	3401-3500	3501-3600	3601-3700	3701-3800	3801-3900	3901-4000	4001-4100	4101-4200	4201-4300	4301-4400	4401-4500
712	721	735	743	758	790	805	813	830	855	899	909	924	935	950	975	990	1000	1015	1027
722	730	745	753	768	801	816	824	841	866	911	921	936	948	963	989	1004	1013	1028	1041
728	735	750	758	773	807	822	830	847	872	921	930	945	957	972	999	1015	1024	1040	1052
736	744	759	767	783	816	832	840	858	882	932	941	957	968	984	1012	1027	1037	1053	1066
747	755	771	778	794	828	844	852	870	895	945	955	971	982	998	1026	1042	1052	1068	1081
762	770	786	794	810	846	862	870	888	914	965	975	991	1003	1020	1049	1065	1075	1092	1105
787	795	812	821	837	890	906	916	935	962	997	1007	1024	1037	1053	1083	1100	1111	1127	1142
796	805	822	831	848	901	918	927	946	974	1010	1020	1037	1050	1067	1097	1114	1126	1143	1157
813	822	840	849	866	920	938	948	967	996	1032	1043	1061	1074	1091	1122	1140	1151	1169	1183
821	830	847	855	873	926	943	952	972	1000	1036	1046	1064	1076	1093	1124	1141	1152	1169	1184
826	833	851	859	877	932	950	958	978	1006	1044	1054	1072	1084	1102	1134	1152	1162	1180	1195
868	879	896	906	924	962	981	990	1010	1040	1078	1089	1107	1121	1138	1171	1189	1201	1219	1234
879	888	907	916	934	973	991	1002	1022	1051	1090	1101	1120	1133	1151	1185	1203	1215	1233	1248
896	906	925	934	953	993	1012	1022	1043	1073	1113	1124	1143	1157	1175	1210	1229	1241	1259	1275
906	916	935	945	963	1004	1023	1033	1054	1085	1125	1137	1156	1169	1188	1223	1242	1254	1273	1289
927	938	957	967	987	1028	1047	1058	1079	1111	1152	1164	1184	1198	1217	1252	1272	1285	1304	1320
949	960	980	991	1011	1050	1093	1105	1127	1139	1180	1193	1213	1228	1248	1282	1302	1315	1335	1351
1011	1023	1043	1055	1076	1117	1162	1174	1197	1210	1254	1267	1288	1304	1325	1361	1382	1395	1417	1434
1027	1039	1061	1073	1094	1135	1181	1194	1217	1231	1276	1289	1311	1327	1348	1384	1406	1420	1487	1505
1038	1051	1072	1084	1106	1148	1194	1207	1230	1244	1289	1304	1325	1340	1362	1444	1466	1481	1503	1521
1055	1068	1090	1102	1124	1166	1214	1227	1251	1264	1311	1324	1346	1363	1430	1469	1491	1506	1528	1547
1086	1099	1122	1135	1157	1201	1249	1263	1288	1302	1349	1364	1431	1449	1471	1595	1617	1636	1659	1680
1097	1111	1133	1147	1170	1214	1262	1277	1301	1316	1363	1423	1446	1464	1487	1611	1634	1653	1676	1697
1115	1129	1152	1166	1190	1234	1283	1298	1323	1384	1432	1447	1470	1489	1512	1638	1661	1681	1704	1726
1127	1140	1164	1178	1202	1247	1297	1311	1382	1397	1446	1462	1485	1504	1527	1654	1677	1698	1721	1743
1138	1152	1175	1191	1214	1260	1310	1370	1395	1411	1460	1476	1499	1519	1542	1670	1694	1714	1738	1851
1177	1191	1216	1259	1282	1330	1400	1416	1442	1459	1586	1606	1630	1654	1678	1726	1750	1772	1796	
1188	1203	1227	1271	1340	1389	1413	1429	1456	1473	1601	1622	1646	1670	1722	1742	1767	1789		
1206	1221	1246	1336	1361	1410	1435	1451	1478	1496	1625	1647	1671	1724	1749	1769	1794			
1218	1233	1304	1349	1374	1423	1448	1464	1492	1510	1641	1689	1715	1740	1765	1846				
1230	1290	1316	1361	1386	1436	1461	1478	1505	1523	1683	1705	1731	1756	1839					
1315	1331	1357	1404	1430	1556	1582	1603	1632	1681	1707	1730	1756	1840						
1326	1343	1369	1417	1443	1570	1596	1617	1672	1696	1722	1802	1828							
1345	1361	1388	1436	1463	1591	1618	1667	1696	1720	1802	2031								
1357	1373	1400	1449	1476	1606	1658	1681	1710	1790	2022									
1368	1386	1412	1462	1489	1645	1673	1696	1779	2010										
1475	1498	1525	1579	1632	1667	1695	1773	2007											
1488	1511	1539	1617	1646	1681	1762	1992	2023											
1507	1530	1582	1639	1667	1756	1989	2016												
1520	1567	1596	1652	1731	1975	2003													
1532	1580	1609	1717	1950	1989	2018													

- BLIND MOTOR 6 Nm
- BLIND MOTOR 9 Nm
- BLIND MOTOR 10 Nm
- BLIND MOTOR 20 Nm

**EXTRA CHARGE**

Maximum area	16 m <sup>2</sup>
Minimum width (F-FBR guides) *****	574 mm
Minimum height	600 mm
Maximum width	4500 mm
Maximum height	5000 mm
Max. height external blind with mosquito net	2500 mm
Min. width external blind with mosquito net with the use of breake	670 mm
Maximum width of mosquito net	1800 mm
Minimum width of mosquito net	605 mm
Maximum area of mosquito net	4,5m <sup>2</sup>
Maximum area (Crank mechanism)	9 m <sup>2</sup>
Minimum width (Crank mechanism)	520 mm

**STANDARD EQUIPMENT**

Top rail handles	F-USG
Guides	F-FBR
Slat rotation	90°
Bracket for the box ZF3000-BX outer cover (box over 150cm wide)	
Box insulation (type B) - according to the customer's wish	

NAME	PRICE
Box enlargement	5%
Varnishing the entire box	10%
Varnishing the box in RAL colors **, ****	30%
Guides with an offset ***	10%
Veneering guides ****	8%
Varnishing guides in RAL colors **, ****	20%
Automatic top rail handle F-USG-A	1,70 € / pc
Bracket for the box ZF3000-BX outer cover (box up to 150 cm wide)	8,00 € / pc
Wall mounting bracket	5,00 € / pc
Rolled mosquito-net	103,00 € / pc
Pleated mosquito-net	p. 51
Preparation for the mosquito net	8,70 € / pc
F-FBD-011 / 021 Untere Alu-Endkappe der Führungsschiene F-FBR-010 / 020	7,70 € / Pair
F-FBD-031 / 041 Untere Alu-Endkappe der Führungsschiene F-FBR-030 / 040	8,50 € / Pair
F-FBD-071 Untere Alu-Endkappe der DF-Schiene F-FBR-070	6,30 € / pc
F-FBD-081 Untere Alu-Endkappe der DF-Schiene F-FBR-080	7,30 € / pc
F-FBD-091 Lower aluminum end cap for double guide rail F-FBR-090	7,25 € / pc
F-FBD-101 Lower aluminum end cap for double guide rail with spacer F-FBR-100	7,50 € / pc
F-UPN 60-70 60-70mm corner guide handle	0,70 € / pc
F-UPN 80-100 80-100mm corner guide handle	1,00 € / pc
F-UPNW-75-100 75-100mm internal corner guide handle	2,40 € / pc
F-UPNW-95-140 95-140mm internal corner guide handle	4,40 € / pc
F-PN Corner profile to ZF3000-BX - SET	48,00 € / m
F-PBPL Preparing the side for cable guidance BX	24,80 € / pc
F-SKN Surcharge for corner box	13,70 € / pc
F-LSBX-180 Box connector BX 180 degrees	41,50 € / pc

**HANDLES MOUNTING THE HEAD RAIL**

SAFETY PLATE	PACKAGE HEIGHT	hw	2 TOP RAIL HANDLES									3 TOP RAIL HANDLES							
			600-1000	1001-1100	1101-1200	1201-1300	1301-1400	1401-1500	1501-1600	1601-1700	1701-1800	1801-1900	1901-2000	2001-2100	2101-2200	2201-2300	2301-2400	2401-2500	
250	160	600-1000	426	446	461	466	490	513	527	535	549	556	571	601	616	623	638	663	
		1001-1100	441	456	471	488	503	526	541	549	565	573	588	617	632	642	656	683	
	170	1101-1200	448	464	479	496	511	534	550	559	574	582	597	629	644	653	668	694	
		1201-1300	454	481	496	503	519	542	558	569	585	591	607	638	654	664	680	705	
	180	1301-1400	462	488	504	512	527	551	568	578	594	602	618	649	666	676	692	718	
		1401-1500	478	495	511	519	535	560	576	588	604	610	627	659	675	685	701	730	
	200	1501-1600	487	506	523	532	548	575	613	623	640	650	668	689	706	716	733	762	
		1601-1700	494	512	529	538	555	582	621	632	650	660	677	695	712	721	739	775	
	210	1701-1800	502	519	537	546	564	592	632	643	660	671	688	707	724	733	750	784	
		1801-1900	509	527	544	553	571	596	637	645	663	670	688	709	727	734	752	782	
	220	1901-2000	519	539	557	566	584	610	652	661	680	687	706	727	745	754	772	803	
		2001-2100	536	556	575	596	615	643	674	684	703	711	730	752	771	780	799	831	
230	2101-2200	543	563	582	604	623	652	683	693	712	720	739	762	781	790	809	841		
	2201-2300	550	571	590	612	631	661	693	703	722	731	750	773	793	802	821	854		
240	2301-2400	560	581	601	624	644	675	707	718	738	746	766	790	810	820	840	874		
	2401-2500	570	602	623	631	652	683	716	726	746	756	777	800	821	831	851	886		
300	250	2501-2600	578	621	642	644	695	704	738	749	770	780	800	841	862	898	919	932	
		2601-2700	587	628	649	652	704	713	748	759	781	790	812	853	874	911	933	946	
	260	2701-2800	598	639	661	663	718	727	763	774	796	807	829	870	892	930	952	966	
		2801-2900	605	648	670	672	727	737	773	785	807	818	840	882	905	943	966	979	
	270	2901-3000	612	654	677	680	736	745	782	794	816	826	849	892	915	954	977	990	
		3001-3100	639	672	694	698	754	764	816	829	852	863	887	910	933	979	1002	1016	
	280	3101-3200	646	679	703	706	763	772	825	839	862	873	897	920	943	990	1014	1028	
		3201-3300	658	691	715	719	778	788	842	855	879	891	915	939	963	1011	1035	1050	
	290	3301-3400	665	699	724	727	787	797	851	865	889	901	926	949	974	1022	1047	1061	
		3401-3500	700	737	763	769	832	844	901	916	943	957	984	1009	1036	1088	1114	1131	
	350	300	3501-3600	756	770	797	843	870	884	926	943	970	985	1012	1077	1104	1119	1146	1165
			3601-3700	764	779	806	853	881	896	939	956	983	999	1027	1092	1119	1136	1163	1182
310		3701-3800	772	787	815	863	890	905	949	967	994	1010	1038	1104	1132	1149	1177	1195	
		3801-3900	780	795	823	872	900	915	960	977	1005	1022	1050	1116	1144	1162	1190	1209	
320		3901-4000	788	803	832	881	910	925	970	988	1016	1033	1062	1129	1157	1175	1203	1223	
		4001-4100	813	830	859	911	940	957	1002	1022	1051	1069	1099	1169	1198	1217	1246	1267	
330		4101-4200	820	838	867	920	950	967	1013	1033	1063	1081	1111	1181	1210	1230	1259	1325	
		4201-4300	828	846	876	930	959	977	1024	1044	1074	1093	1122	1193	1223	1243	1273	1339	
340		4301-4400	836	855	884	939	969	988	1034	1055	1085	1104	1134	1206	1236	1256	1331	1353	
		4401-4500	848	866	897	954	985	1003	1051	1072	1102	1122	1153	1226	1257	1322	1353	1375	
350		4501-4600	870	890	921	979	1010	1030	1079	1101	1132	1153	1184	1259	1336	1357	1389	1413	
		4601-4700	878	898	929	989	1020	1041	1089	1113	1144	1165	1196	1272	1349	1371	1402	1426	
360	4701-4800	886	907	938	999	1030	1051	1100	1124	1155	1177	1208	1330	1361	1384	1415	1440		
	4801-4900	894	915	947	1009	1040	1062	1111	1134	1166	1188	1265	1343	1375	1398	1429	1454		
370	4901-5000	906	927	960	1023	1056	1077	1128	1152	1184	1207	1284	1363	1396	1419	1452	1477		

With Z90 AiB over 440 cm high, the package will protrude beyond the box.

## EXTRA CHARGES FOR MOTORS

NAME	6 Nm	9 Nm	10 Nm	18 Nm	20 Nm
AM55 / VB55	VB55-6/22EL Included in the price	-	AM55-10/35-EL Included in the price	-	-
ELERO SOFT	JA 06 SOFT Included in the price	JA 09 SOFT Included in the price	-	-	JA 20 DK Included in the price
SOMFY WT	J406 6/24WT 39,40 €	-	J410 10/24WT 40,50 €	J418 18/24WT 62,90 €	-
SOMFY WT PROTECT	J406 6/24WT PROTECT 74,70 €	-	J410 10/24WT PROTECT 51,90 €	J418 18/24WT PROTECT 82 €	-
ELERO COMFORT	JA 06 COMFORT-868 131,70 €	JA 09 COMFORT-868 157,40 €	-	-	-
SOMFY RTS	J406 6/24 RTS 171,70 €	-	J410 10/24 RTS 183,20 €	J418 18/24 RTS 208,90 €	-
SOMFY IO PROTECT	J406 6/24 IO PROTECT 171,70 €	-	J410 10/24 IO PROTECT 183,20 €	J418 18/24 IO PROTECT 208,90 €	-
ELERO NHK	-	JA 09 NHK ZESTAW* 878,10 €	-	-	-

- \* - Product for special order
- \*\* - colors other than the standard colours of the ZF3000 external blinds.  
In the case of little saleable RAL colors - individual valuation.
- \*\*\* - surcharge applies only to type A.
- \*\*\*\* - completion date up to 21 business days.
- \*\*\*\*\* - detailed table of minimum widths on p. 61.

CRANK MECHANISM (set) - 20,60 €  
CRANK STEM EXTENSION - 14,20 €/m

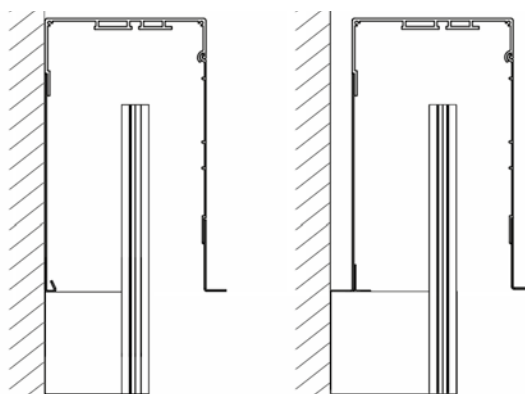

**TYP A** - Flush-mount-  
ed box. Dedicated  
F-FBR-030 guides.

**TYP B** - Flush-mounted  
box with an offset. Dedic-  
ated F-FBR-040 guides.

### HANDLES MOUNTING THE HEAD RAIL

4 TOP RAIL HANDLES							5 TOP RAIL HANDLES							6 TOP RAIL HANDLES					
2501-2600	2601-2700	2701-2800	2801-2900	2901-3000	3001-3100	3101-3200	3201-3300	3301-3400	3401-3500	3501-3600	3601-3700	3701-3800	3801-3900	3901-4000	4001-4100	4101-4200	4201-4300	4301-4400	4401-4500
690	697	712	721	735	768	782	789	806	829	873	883	897	908	923	950	964	974	988	1000
710	718	733	743	758	790	805	812	830	855	900	910	925	936	952	979	994	1004	1019	1032
722	731	746	756	772	804	820	828	846	870	916	927	942	953	969	998	1013	1023	1038	1051
734	745	760	768	784	816	832	841	859	887	933	945	960	971	987	1013	1029	1038	1054	1067
746	757	773	782	798	831	847	856	874	901	949	961	977	989	1005	1030	1047	1056	1073	1086
759	768	785	795	811	845	861	872	890	917	965	975	991	1003	1019	1046	1062	1072	1089	1102
793	803	821	832	849	898	915	924	943	973	1007	1021	1038	1050	1067	1095	1112	1123	1140	1155
806	815	833	842	859	910	927	936	956	986	1020	1031	1049	1061	1079	1107	1125	1136	1153	1167
815	828	847	856	873	925	942	952	972	1002	1037	1048	1066	1079	1097	1125	1143	1154	1172	1187
815	823	841	850	867	921	939	948	968	999	1035	1046	1064	1076	1094	1125	1143	1154	1172	1186
837	846	864	873	892	946	965	974	995	1027	1064	1075	1094	1107	1125	1157	1176	1187	1205	1220
881	892	910	921	939	979	998	1007	1029	1062	1101	1112	1131	1145	1164	1196	1215	1227	1246	1262
893	903	923	933	952	991	1011	1021	1042	1076	1115	1127	1146	1160	1179	1212	1232	1244	1264	1279
907	916	936	947	966	1006	1026	1036	1058	1092	1132	1144	1164	1178	1198	1231	1251	1263	1283	1299
927	938	958	969	989	1029	1050	1061	1083	1119	1160	1172	1192	1206	1227	1261	1281	1294	1314	1331
941	952	972	983	1004	1045	1066	1077	1100	1136	1179	1191	1212	1226	1247	1283	1304	1317	1337	1354
970	981	1003	1014	1035	1073	1125	1137	1160	1173	1216	1229	1250	1265	1286	1319	1341	1354	1376	1393
985	997	1018	1030	1052	1090	1143	1155	1179	1192	1235	1248	1270	1286	1307	1341	1362	1375	1397	1415
1006	1018	1040	1053	1075	1114	1168	1181	1205	1218	1263	1277	1299	1315	1337	1370	1392	1407	1435	1453
1019	1032	1055	1067	1089	1129	1184	1197	1221	1235	1280	1294	1317	1332	1354	1394	1417	1432	1454	1473
1031	1045	1067	1079	1102	1142	1198	1211	1236	1249	1295	1308	1331	1347	1376	1411	1434	1449	1472	1491
1058	1071	1094	1103	1126	1172	1229	1242	1268	1280	1328	1338	1368	1384	1408	1529	1552	1571	1594	1615
1071	1084	1107	1116	1139	1185	1243	1257	1283	1295	1344	1360	1383	1401	1424	1548	1571	1589	1613	1634
1093	1108	1131	1140	1164	1212	1271	1283	1310	1331	1379	1390	1414	1432	1456	1581	1606	1625	1649	1671
1106	1120	1144	1153	1177	1224	1284	1298	1331	1346	1395	1406	1431	1449	1473	1600	1625	1643	1668	1690
1178	1194	1220	1231	1258	1306	1369	1431	1466	1489	1541	1548	1575	1595	1622	1752	1779	1800	1827	2001
1212	1228	1255	1305	1332	1382	1455	1472	1507	1537	1662	1673	1700	1724	1751	1858	1886	1910	1937	
1230	1247	1275	1325	1398	1449	1477	1495	1525	1543	1678	1697	1725	1749	1864	1889	1917	1941		
1245	1261	1289	1386	1413	1465	1493	1512	1541	1560	1697	1716	1744	1857	1885	1910	1938			
1259	1275	1348	1401	1429	1481	1510	1528	1559	1578	1715	1820	1849	1877	1905	1992				
1273	1334	1363	1416	1445	1498	1526	1545	1576	1595	1817	1840	1869	1897	1986					
1363	1381	1410	1466	1495	1628	1657	1681	1712	1819	1848	1873	1903	1992						
1377	1395	1424	1482	1511	1645	1675	1698	1812	1838	1868	1952	1982							
1392	1409	1439	1497	1527	1662	1692	1798	1830	1857	1944	2173								
1406	1423	1453	1512	1542	1679	1789	1816	1849	1933	2165									
1429	1447	1477	1538	1569	1788	1818	1846	1936	2167										
1536	1559	1590	1657	1766	1805	1837	1921	2156											
1551	1574	1605	1752	1783	1823	1910	2141	2176											
1566	1589	1697	1769	1801	1896	2130	2160												
1581	1680	1712	1786	1872	2115	2148													
1605	1705	1739	1868	2102	2145	2178													

**EXTRA CHARGE**

Maximum area	16 m <sup>2</sup>
Minimum width (F-FBR guides) *****	574 mm
Minimum height	600 mm
Maximum width	4500 mm
Maximum height	5000 mm
Max. height external blind with mosquito net	2500 mm
Min. width external blind with mosquito net with the use of breake	670 mm
Maximum width of mosquito net	1800 mm
Minimum width of mosquito net	605 mm
Maximum area of mosquito net	4,5m <sup>2</sup>
Maximum area (Crank mechanism)	9 m <sup>2</sup>
Minimum width (Crank mechanism)	520 mm

**STANDARD EQUIPMENT**

Top rail handles	F-USG
Guides	F-FBR
Slat rotation	90°
Bracket for the box ZF3000-BX outer cover (box over 150cm wide)	
Box insulation (type D) - according to the customer's wish	

NAME	PRICE
Box enlargement	5%
Varnishing the box in RAL colors **, ****	30%
Guides with an offset ***	10%
Veneering guides *****	8%
Varnishing guides in RAL colors **, ****	20%
Automatic top rail handle F-USG-A	1,70 € / pc
Bracket for the box ZF3000-BX outer cover (box up to 150 cm wide)	8,00 € / pc
Wall mounting bracket	5,00 € / pc
Rolled mosquito-net	103,00 € / pc
Pleated mosquito-net	p. 51
Preparation for the mosquito net	8,70 € / pc
F-FBD-011 / 021 Untere Alu-Endkappe der Führungsschiene F-FBR-010 / 020	7,70 € / Pair
F-FBD-031 / 041 Untere Alu-Endkappe der Führungsschiene F-FBR-030 / 040	8,50 € / Pair
F-FBD-071 Untere Alu-Endkappe der DF-Schiene F-FBR-070	6,30 € / pc
F-FBD-081 Untere Alu-Endkappe der DF-Schiene F-FBR-080	7,30 € / pc
F-FBD-091 Lower aluminum end cap for double guide rail F-FBR-090	7,25 € / pc
F-FBD-101 Lower aluminum end cap for double guide rail with spacer F-FBR-100	7,50 € / pc
F-UPN 60-70 60-70mm corner guide handle	0,70 € / pc
F-UPN 80-100 80-100mm corner guide handle	1,00 € / pc
F-UPNW-75-100 75-100mm internal corner guide handle	2,40 € / pc
F-UPNW-95-140 95-140mm internal corner guide handle	4,40 € / pc
F-PN Corner profile to ZF3000-BX - SET	48,00 € / rm
F-PBPL Preparing the side for cable guidance BX	24,80 € / pc
F-SKN Surcharge for corner box	13,70 € / pc
F-LSBX-180 Box connector BX 180 degrees	41,50 € / pc

**HANDLES MOUNTING THE HEAD RAIL**

SAFETY PLATE	PACKAGE HEIGHT	h/w	2 TOP RAIL HANDLES								3 TOP RAIL HANDLES								
			600-1000	1001-1100	1101-1200	1201-1300	1301-1400	1401-1500	1501-1600	1601-1700	1701-1800	1801-1900	1901-2000	2001-2100	2101-2200	2201-2300	2301-2400	2401-2500	
250	160	600-1000	454	477	491	499	523	547	572	581	596	604	619	637	652	660	675	700	
		1001-1100	470	487	503	521	536	561	587	597	613	620	636	655	671	679	694	720	
	170	1101-1200	477	495	511	529	545	570	596	607	623	631	647	666	682	690	706	733	
		1201-1300	484	512	528	537	554	580	607	616	633	640	656	677	693	701	717	744	
	180	1301-1400	492	520	537	546	563	588	615	627	643	651	668	688	705	713	730	757	
		1401-1500	508	528	544	554	571	598	626	636	653	661	678	698	715	723	740	768	
	200	1501-1600	519	548	566	576	594	623	652	663	681	691	708	729	747	757	774	804	
		1601-1700	526	556	573	583	601	629	658	668	686	695	713	735	753	762	780	811	
	210	1701-1800	535	564	581	592	610	639	668	679	697	706	724	747	765	775	793	824	
		1801-1900	541	567	585	593	612	639	670	680	698	706	724	747	766	774	793	824	
	220	1901-2000	552	580	598	606	626	654	686	696	715	724	743	765	785	794	813	846	
		2001-2100	568	588	607	627	646	677	709	720	739	749	768	792	812	822	842	876	
	230	2101-2200	578	596	615	635	655	686	718	730	749	759	778	803	823	833	853	888	
		2201-2300	584	604	624	644	664	696	729	740	760	770	790	814	835	845	865	901	
	240	2301-2400	595	616	636	657	677	710	744	755	776	786	807	833	853	864	885	921	
		2401-2500	607	636	656	664	684	717	751	761	781	790	810	835	856	865	886	921	
300	250	2501-2600	625	655	676	679	730	740	774	785	806	815	836	879	900	937	958	971	
		2601-2700	631	662	683	687	739	748	783	795	816	825	847	890	911	950	971	984	
	260	2701-2800	642	674	695	700	753	763	799	810	832	843	865	909	930	970	991	1006	
		2801-2900	650	683	705	708	763	772	809	821	844	854	876	921	943	983	1005	1019	
	270	2901-3000	658	690	713	717	772	781	819	831	854	864	886	931	954	995	1018	1032	
		3001-3100	676	709	732	737	793	804	857	870	893	905	928	954	976	1023	1046	1061	
	280	3101-3200	683	717	740	745	803	812	866	880	903	915	938	965	988	1035	1058	1073	
		3201-3300	695	730	753	759	818	828	883	897	921	934	958	985	1008	1057	1081	1096	
	290	3301-3400	703	738	763	768	827	838	893	908	932	945	969	996	1019	1069	1093	1109	
		3401-3500	753	790	815	821	883	895	951	967	992	1007	1031	1060	1085	1136	1162	1178	
	350	300	3501-3600	810	825	850	897	922	937	978	996	1021	1036	1062	1129	1154	1170	1196	1214
			3601-3700	822	837	863	911	937	952	995	1012	1039	1054	1080	1149	1175	1192	1218	1237
		310	3701-3800	830	845	872	921	948	963	1005	1024	1050	1066	1093	1162	1188	1205	1232	1251
			3801-3900	838	854	881	931	958	973	1016	1035	1062	1078	1105	1174	1201	1219	1245	1265
		320	3901-4000	847	863	890	941	968	983	1027	1046	1073	1090	1117	1187	1214	1232	1259	1279
			4001-4100	872	889	917	971	999	1016	1061	1081	1109	1127	1155	1228	1256	1276	1303	1325
330		4101-4200	881	898	926	981	1009	1027	1072	1093	1120	1139	1168	1241	1269	1290	1318	1384	
		4201-4300	889	907	935	991	1019	1037	1083	1104	1132	1151	1180	1254	1283	1303	1332	1399	
340		4301-4400	897	915	944	1001	1030	1048	1094	1115	1144	1164	1192	1268	1296	1317	1391	1413	
		4401-4500	910	928	958	1016	1045	1064	1111	1133	1162	1182	1212	1288	1318	1384	1413	1436	
350		4501-4600	932	952	982	1042	1072	1092	1140	1163	1193	1214	1244	1323	1398	1421	1450	1475	
		4601-4700	940	961	991	1052	1082	1103	1151	1174	1204	1226	1256	1336	1412	1434	1464	1489	
360		4701-4800	949	970	1000	1062	1093	1114	1162	1186	1216	1238	1269	1395	1425	1448	1479	1504	
		4801-4900	958	979	1010	1073	1103	1124	1173	1198	1228	1251	1327	1408	1439	1462	1493	1518	
370		4901-5000	970	992	1023	1088	1119	1141	1191	1215	1247	1269	1346	1429	1460	1484	1516	1541	

With Z90 CiD over 440 cm high, the package will protrude beyond the box.

## EXTRA CHARGES FOR MOTORS

NAME	6 Nm	9 Nm	10 Nm	18 Nm	20 Nm
AM55 / VB55	VB55-6/22EL Included in the price	-	AM55-10/35-EL Included in the price	-	-
ELERO SOFT	JA 06 SOFT Included in the price	JA 09 SOFT Included in the price	-	-	JA 20 DK Included in the price
SOMFY WT	J406 6/24WT 39,40 €	-	J410 10/24WT 40,50 €	J418 18/24WT 62,90 €	-
SOMFY WT PROTECT	J406 6/24WT PROTECT 74,70 €	-	J410 10/24WT PROTECT 51,90 €	J418 18/24WT PROTECT 82 €	-
ELERO COMFORT	JA 06 COMFORT-868 131,70 €	JA 09 COMFORT-868 157,40 €	-	-	-
SOMFY RTS	J406 6/24 RTS 171,70 €	-	J410 10/24 RTS 183,20 €	J418 18/24 RTS 208,90 €	-
SOMFY IO PROTECT	J406 6/24 IO PROTECT 171,70 €	-	J410 10/24 IO PROTECT 183,20 €	J418 18/24 IO PROTECT 208,90 €	-
ELERO NHK	-	JA 09 NHK ZESTAW* 878,10 €	-	-	-

- \* - Product for special order
- \*\* - colors other than the standard colours of the ZF3000 external blinds.  
In the case of little saleable RAL colors - individual valuation.
- \*\*\* - surcharge applies only to type A.
- \*\*\*\* - completion date up to 21 business days.
- \*\*\*\*\* - detailed table of minimum widths on p. 61.

CRANK MECHANISM (set) - 20,60 €  
CRANK STEM EXTENSION - 14,20 €/m

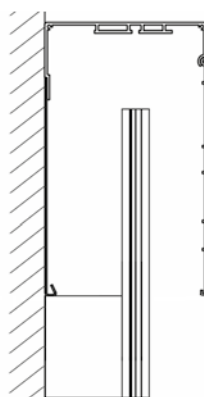

**TYP C** - Facade box.  
Dedicated F-FBR-010  
guides.

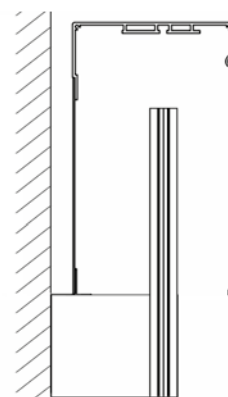

**TYP D** - Facade box  
with an offset. Dedicated  
F-FBR-020 guides.

### HANDLES MOUNTING THE HEAD RAIL

4 TOP RAIL HANDLES							5 TOP RAIL HANDLES							6 TOP RAIL HANDLES					
2501-2600	2601-2700	2701-2800	2801-2900	2901-3000	3001-3100	3101-3200	3201-3300	3301-3400	3401-3500	3501-3600	3601-3700	3701-3800	3801-3900	3901-4000	4001-4100	4101-4200	4201-4300	4301-4400	4401-4500
728	736	751	759	774	808	823	831	848	873	920	929	945	956	972	998	1013	1023	1039	1051
749	757	773	782	798	832	848	856	874	900	948	958	974	986	1002	1029	1045	1056	1072	1085
762	771	787	796	812	846	862	872	890	916	965	975	992	1004	1020	1048	1064	1075	1091	1105
774	783	799	808	824	859	876	885	903	930	980	991	1007	1020	1036	1065	1081	1092	1108	1122
787	797	813	822	838	875	891	900	918	947	998	1009	1025	1038	1055	1083	1101	1112	1128	1142
799	808	825	834	851	887	904	913	932	961	1013	1024	1041	1053	1071	1100	1117	1129	1146	1160
836	846	864	874	891	946	963	973	993	1025	1060	1072	1090	1104	1122	1153	1170	1183	1201	1216
844	854	872	882	900	955	973	984	1004	1036	1073	1085	1103	1117	1135	1167	1185	1198	1216	1231
858	868	886	897	915	971	989	1000	1021	1053	1091	1103	1121	1135	1154	1186	1204	1217	1235	1251
859	869	887	897	915	973	991	1002	1023	1055	1094	1106	1125	1138	1157	1191	1209	1221	1240	1256
882	891	911	921	940	999	1018	1029	1050	1084	1124	1137	1155	1170	1189	1224	1243	1256	1275	1291
929	940	960	972	991	1033	1053	1064	1087	1122	1163	1176	1195	1211	1231	1266	1286	1299	1319	1336
941	953	974	985	1005	1047	1067	1079	1101	1137	1179	1192	1212	1227	1247	1284	1304	1318	1338	1355
956	967	988	1000	1020	1063	1083	1095	1117	1154	1196	1210	1230	1246	1266	1303	1324	1338	1358	1375
978	990	1011	1023	1044	1087	1108	1121	1144	1182	1225	1239	1260	1276	1297	1335	1356	1370	1391	1409
979	990	1011	1021	1042	1086	1106	1117	1140	1178	1222	1235	1255	1271	1291	1329	1350	1364	1384	1402
1011	1023	1043	1055	1076	1117	1169	1181	1205	1217	1262	1276	1297	1313	1334	1371	1391	1406	1427	1445
1025	1037	1058	1070	1092	1133	1186	1198	1222	1236	1281	1294	1316	1332	1353	1391	1413	1426	1448	1466
1047	1059	1082	1094	1116	1159	1212	1225	1250	1264	1310	1324	1346	1363	1385	1422	1444	1459	1526	1545
1061	1074	1096	1109	1131	1174	1229	1242	1267	1281	1327	1342	1365	1380	1403	1486	1509	1525	1547	1566
1074	1087	1110	1123	1145	1188	1244	1257	1282	1296	1344	1358	1380	1397	1466	1505	1528	1543	1566	1585
1104	1118	1141	1151	1174	1223	1280	1294	1319	1333	1382	1395	1463	1481	1504	1637	1660	1680	1703	1724
1117	1131	1154	1164	1188	1238	1295	1310	1335	1349	1399	1457	1480	1498	1522	1657	1680	1700	1724	1745
1141	1156	1180	1190	1214	1264	1324	1337	1364	1424	1475	1488	1512	1531	1555	1692	1716	1737	1761	1783
1154	1169	1193	1204	1228	1278	1338	1353	1424	1440	1492	1506	1530	1549	1573	1712	1736	1757	1781	1804
1226	1241	1267	1279	1304	1355	1417	1479	1506	1523	1576	1591	1616	1636	1662	1803	1829	1851	1876	1998
1262	1279	1304	1355	1381	1434	1504	1523	1550	1569	1705	1726	1752	1776	1802	1855	1881	1904	1931	
1285	1302	1329	1381	1452	1506	1532	1551	1579	1598	1737	1758	1785	1810	1867	1890	1917	1941		
1300	1317	1344	1442	1469	1523	1549	1568	1597	1616	1756	1778	1805	1861	1888	1912	1939			
1314	1332	1404	1458	1485	1540	1567	1586	1615	1634	1776	1827	1855	1881	1908	1997				
1329	1391	1419	1474	1501	1556	1584	1603	1633	1653	1824	1847	1875	1902	1993					
1421	1440	1468	1526	1554	1691	1720	1744	1775	1828	1856	1880	1908	1999						
1436	1455	1483	1542	1570	1709	1738	1762	1821	1847	1876	1962	1991							
1451	1470	1498	1558	1586	1727	1756	1809	1841	1866	1955	2186								
1466	1484	1513	1574	1603	1745	1802	1828	1860	1946	2179									
1490	1509	1539	1601	1630	1802	1832	1859	1949	2182										
1601	1625	1655	1725	1782	1820	1850	1936	2172											
1616	1641	1672	1769	1799	1838	1925	2159	2191											
1632	1657	1714	1786	1817	1913	2148	2178												
1648	1699	1730	1804	1890	2135	2167													
1673	1725	1756	1887	2123	2165	2197													

**PORTOS system box data**

Minimum width (F-FBR guides) ***	574 mm
Maximum width	4500 mm
Min. width external blind with mosquito net with the use of breake	670 mm
Maximum width of mosquito net	1800 mm
Minimum width of mosquito net	605 mm
Minimum width (Crank mechanism)	520 mm

**STANDARD EQUIPMENT**

Top rail handles	F-USG
Bracket for the box ZF3000-BX outer cover (box over 150cm wide)	
Box insulation (type B,D) - according to the customer's wish	

**EXTRA CHARGE**

NAME	PRICE
Varnishing the entire box	10%
Varnishing the box in RAL colors *, **	30%
Automatic top rail handle F-USG-A	1,70 € / pc
Bracket for the box ZF3000-BX outer cover (box up to 150 cm wide)	8,00 € / pc
Wall mounting bracket	5,00 € / pc
Preparation for the mosquito net	8,70 € / pc
F-UPN 60-70 60-70mm corner guide handle	0,70 € / pc
F-UPN 80-100 80-100 mm corner guide handle	1,00 € / pc
F-UPNW-75-100 75-100mm internal corner guide handle	2,40 € / pc
F-UPNW-95-140 95-140mm internal corner guide handle	4,40 € / pc
F-PN Corner profile to ZF3000-BX - SET	48,00 € / m
F-PBPL Preparing the side for cable guidance BX	24,80 € / pc
F-SKN Surcharge for corner box	13,70 € / pc
F-LSBX-180 Box connector BX 180 degrees	41,50 € / pc

\* - colors other than the standard colours of the ZF3000 external blinds. In the case of little saleable RAL colors - individual valuation.

\*\* - completion date up to 21 business days.

\*\*\* - detailed table of minimum widths on p. 61.

**HANDLES MOUNTING THE HEAD RAIL**

MOUNTING TYPE	Safety plate/width	2 TOP RAIL HANDLES								3 TOP RAIL HANDLES								
		600-1000	1001-1100	1101-1200	1201-1300	1301-1400	1401-1500	1501-1600	1601-1700	1701-1800	1801-1900	1901-2000	2001-2100	2101-2200	2201-2300	2301-2400	2401-2500	2501-2600
A, B	250	151	158	166	174	181	189	197	206	214	222	229	237	245	253	260	270	278
A, B	300	165	173	182	190	199	207	216	226	235	243	252	261	269	278	286	297	305
A, B	350	180	189	198	208	217	227	236	247	257	266	275	285	294	303	313	324	334
C, D	250	156	165	173	181	189	197	205	215	223	231	240	248	256	264	272	282	290
C, D	300	170	179	187	195	203	211	219	229	237	245	254	262	270	278	286	296	304
C, D	350	198	206	214	222	230	238	247	257	265	273	281	289	297	305	314	324	332

## EXTRA CHARGE

SYMBOL	NAME	PRICE
F-FBR-010	Guide adapter for external blind	17,80 €/rm
F-FBR-010 REN	Varnishing the guide adapter for external blind except for the woodec turner oak(42) *	24,90 €/rm
F-FBR-010 REN 42	Varnishing the guide adapter for external blind in color 42 woodec turner oak *	28,60 €/rm
F-FBR-020	Guide adapter for external blind with a spacer	22,10 €/rm
F-FBR-020 REN	Varnishing the guide adapter for external blind with a spacer except for the woodec turner oak(42) *	28,80 €/rm
F-FBR-020 REN 42	Varnishing the guide adapter for external blind with a spacer in color 42 woodec turner oak *	33,10 €/rm
F-FBR-030	Guide for external blind for flush-mounted installation	21,40 €/rm
F-FBR-030 REN	Varnishing the guide for external blind for flush-mounted installation except for the woodec turner oak(42) *	27,90 €/rm
F-FBR-030 REN 42	Varnishing the guide for external blind for flush-mounted installation in color 42 woodec turner oak *	32,10 €/rm
F-FBR-040	Guide for external blind for flush-mounted installation with a spacer	24,00 €/rm
F-FBR-040 REN	Guide for external blind for flush-mounted installation with a spacer except for the woodec turner oak(42) *	31,30 €/rm
F-FBR-040 REN 42	Guide for external blind for flush-mounted installation with a spacer in color 42 woodec turner oak *	35,90 €/rm
F-RSC-340	Insert guide for external blinds	4,00 €/rm
F-PP-20	External blind single guide (with the use of the F-FBR adapter)	6,50 €/rm
F-FBR-090	Adapter for double partition guide rail	122,00 €/rm
F-FBR-100	Adapter for double partition guide rail with spacer	129,00 €/rm
F-FBD-010	Bottom plug of the F-FBR-010 guide	0,80 €/Pair
F-FBD-020	Bottom plug of the F-FBR-020 guide	0,80 €/Pair
F-FBD-030	Bottom plug of the F-FBR-030 guide	0,50 €/Pair
F-FBD-040	Bottom plug of the F-FBR-040 guide	0,60 €/Pair
F-FBD-011	Bottom alu plug of the F-FBR-010 guide	7,70 €/Pair
F-FBD-021	Bottom alu plug of the F-FBR-020 guide	7,70 €/Pair
F-FBD-031	Bottom alu plug of the F-FBR-030 guide	8,50 €/Pair
F-FBD-041	Bottom alu plug of the F-FBR-040 guide	8,50 €/Pair
F-FBD-071	Untere Alu-Endkappe der DF-Schiene F-FBR-070	6,30 €/ pc
F-FBD-081	Untere Alu-Endkappe der DF-Schiene F-FBR-080	7,30 €/ pc
F-FBD-091	Lower aluminum end cap for double guide rail F-FBR-090	7,25 €/ pc
F-FBD-101	Lower aluminum end cap for double guide rail with spacer F-FBR-100	7,50 €/ pc

\* - completion date up to 21 business days.

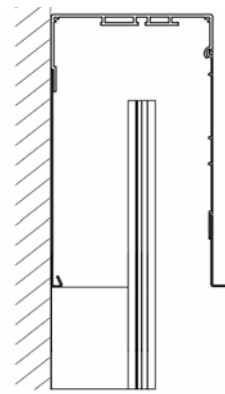

**TYP A** - Flush-mounted box. Dedicated F-FBR-030 guides.

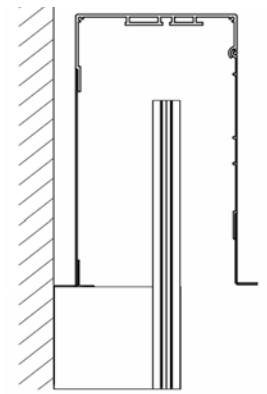

**TYP B** - Flush-mounted box with an offset. Dedicated F-FBR-040 guides.

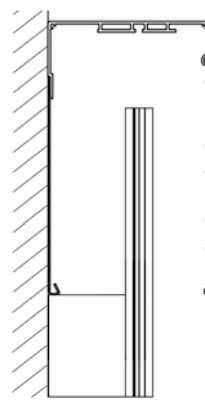

**TYP C** - Facade box. Dedicated F-FBR-010 guides.

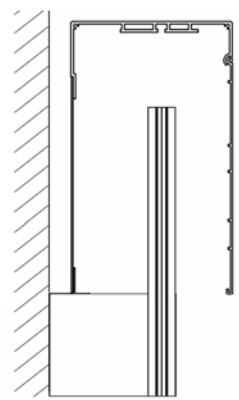

**TYP D** - Facade box with an offset. Dedicated F-FBR-020 guides.

## HANDLES MOUNTING THE HEAD RAIL

4 TOP RAIL HANDLES								5 TOP RAIL HANDLES						6 TOP RAIL HANDLES				
2601-2700	2701-2800	2801-2900	2901-3000	3001-3100	3101-3200	3201-3300	3301-3400	3401-3500	3501-3600	3601-3700	3701-3800	3801-3900	3901-4000	4001-4100	4101-4200	4201-4300	4301-4400	4401-4500
285	293	301	308	316	324	331	341	349	356	364	372	381	389	397	404	412	420	427
314	322	331	339	348	356	365	375	384	392	401	409	420	428	437	445	454	462	471
343	352	362	371	380	390	399	410	420	429	439	448	459	469	478	487	497	506	515
298	307	315	323	331	339	347	357	365	373	382	390	400	408	416	424	432	440	449
312	321	329	337	345	353	361	371	379	387	396	404	414	422	430	438	446	454	463
340	348	356	364	372	380	389	399	407	415	423	431	441	449	457	466	474	482	490

Minimum width (F-FBR guides) ***	574 mm
Maximum width	4500 mm
Min. width external blind with mosquito net with the use of breake	670 mm
Maximum width of mosquito net	1800 mm
Minimum width of mosquito net	605 mm
Minimum width (Crank mechanism)	520 mm

**STANDARD EQUIPMENT**

Top rail handles	F-USG
Lintel bracket of the slat profile goes with the external blinds	F-NPTK-090
Steel side handles	NPT-150
EPS foam inserts to the box sides	F-NPW-310
F-FBR-030 guide rails	F-FBR
PVC bottom end cap of the guide rail, at the client's request	
Slat rotation	90°/180°

**EXTRA CHARGE**

NAME	PRICE
Veneering guides **	8%
Varnishing guides in RAL colors *, **	20%
F-FBR-070 Double guide rail adapter	26,10€/m
F-FBR-080 Double guide rail distance adapter	28,10€/m
Box elevation by 3 cm	13,60€/m
Box lowering by 3 cm	2,90€/m
Plastering strip in the colour of the set (for colours - see page 2 of the cover)	4,00€/m
Automatic top rail handle F-USG-A	1,70€ / pc
Stabilising console F-NPTK-080	17,20€ / pc
Mosquito net	93,80€ / pc
F-FBD-011 Bottom alu plug of the F-FBR-010 guide	7,70€/Pair
F-FBD-021 Bottom alu plug of the F-FBR-020 guide	7,70€/Pair
F-FBD-031 Bottom alu plug of the F-FBR-030 guide	8,50€/Pair
F-FBD-041 Bottom alu plug of the F-FBR-040 guide	8,50€/Pair
F-FBD-071 Aluminium flat bottom end cap of divider guide rail F-FBR-070	6,30€ / pc
F-FBD-081 Aluminium flat bottom end cap of divider guide rail F-FBR-080	7,30€ / pc

- \* - colors other than the standard colours of the ZF3000 external blinds. In the case of little saleable RAL colors - individual valuation
- \*\* - completion date up to 21 business days
- \*\*\* - detailed table of minimum widths on p. 61

**HANDLES MOUNTING THE HEAD RAIL**

SAFETY PLATE	PACKAGE HEIGHT	h/w	2 TOP RAIL HANDLES							3 TOP RAIL HANDLES								
			600-1000	1001-1100	1101-1200	1201-1300	1301-1400	1401-1500	1501-1600	1601-1700	1701-1800	1801-1900	1901-2000	2001-2100	2101-2200	2201-2300	2301-2400	2401-2500
250	200	600-1000	599	613	626	645	658	682	695	724	738	753	767	782	796	810	825	869
		1001-1100	606	620	634	653	667	691	705	732	747	762	777	792	806	821	836	880
		1101-1200	616	630	645	664	678	703	717	746	761	776	791	806	822	837	852	897
	220	1201-1300	623	638	653	672	687	711	726	755	770	786	801	817	832	847	862	908
		1301-1400	631	645	660	680	695	720	735	764	780	795	811	827	842	858	873	919
		1401-1500	641	656	671	691	706	732	747	777	793	809	825	841	857	874	890	936
230	1501-1600	648	664	679	699	715	741	757	786	802	818	835	851	868	884	900	946	
	1601-1700	655	671	687	708	723	749	766	796	812	829	845	861	878	894	911	958	
250 + lowering or raising	250	1701-1800	665	681	697	718	735	762	778	808	825	842	859	876	893	910	927	974
		1801-1900	672	689	706	726	743	771	787	818	835	852	869	886	903	921	937	986
	1901-2000	682	699	716	737	754	783	799	830	848	866	883	901	919	936	954	1002	
260	2001-2100	690	707	724	746	763	791	809	839	858	876	893	911	929	947	965	1013	
	2101-2200	697	714	732	754	771	800	818	849	867	885	903	921	939	957	975	1025	
250 + lowering + raising	270	2201-2300	707	725	742	765	783	812	830	862	880	899	918	936	955	973	991	1041
		2301-2400	714	732	750	773	791	821	839	871	889	908	927	946	964	983	1002	1052
	280	2401-2500	724	742	761	784	802	833	851	884	904	922	941	961	980	999	1019	1069
		2501-2600	732	751	769	792	823	842	861	893	913	932	951	971	990	1021	1041	1080
	300	2601-2700	739	758	777	800	831	851	869	902	922	941	961	981	1000	1032	1052	1091
		2701-2800	749	768	788	812	843	863	882	915	935	956	975	996	1015	1048	1068	1108
	310	2801-2900	756	776	795	820	851	871	891	925	945	965	985	1006	1026	1059	1079	1119
		2901-3000	766	786	806	830	863	883	903	937	958	979	999	1020	1041	1075	1095	1136
	320	3001-3100	773	794	814	839	872	892	913	947	967	989	1009	1031	1051	1085	1106	1147
		3101-3200	781	801	822	847	880	901	921	956	977	998	1019	1041	1061	1096	1117	1158
	340	3201-3300	791	812	833	858	892	913	934	969	991	1012	1034	1055	1077	1112	1134	1175
		3301-3400	798	819	841	866	901	922	943	978	1000	1021	1043	1065	1087	1122	1144	1186
350	3401-3500	805	827	848	874	909	931	952	987	1009	1031	1053	1075	1097	1133	1155	1196	
	3501-3600	815	837	859	899	921	943	965	1000	1023	1045	1068	1104	1126	1149	1172	1214	
370	3601-3700	823	845	867	908	930	951	973	1009	1032	1054	1077	1114	1137	1160	1182	1224	
	3701-3800	833	855	877	919	941	963	986	1023	1045	1068	1092	1129	1152	1175	1199	1241	
380	3801-3900	840	863	885	927	949	972	995	1031	1054	1078	1102	1139	1163	1186	1209	1252	
	3901-4000	848	870	893	935	958	981	1004	1041	1065	1088	1111	1150	1173	1197	1220	1264	
400	4001-4100	858	881	904	946	970	993	1017	1054	1078	1102	1126	1165	1189	1213	1237	1316	
	4101-4200	865	888	912	955	978	1001	1025	1063	1087	1111	1136	1175	1199	1223	1247	1327	
410	4201-4300	874	898	923	965	990	1014	1038	1076	1100	1125	1150	1189	1215	1239	1300	1344	
	4301-4400	882	906	930	974	998	1023	1047	1085	1110	1135	1160	1200	1225	1286	1310	1355	
430	4401-4500	889	914	938	982	1007	1032	1056	1094	1119	1144	1170	1210	1271	1296	1322	1366	
	4501-4600	899	924	949	994	1019	1043	1068	1107	1133	1158	1184	1225	1286	1312	1338	1383	
440	4601-4700	907	932	957	1002	1027	1052	1077	1116	1142	1168	1193	1271	1297	1323	1348	1394	
	4701-4800	917	942	968	1013	1039	1064	1090	1129	1156	1181	1244	1286	1312	1339	1365	1411	
450	4801-4900	924	950	976	1022	1048	1073	1099	1138	1165	1192	1254	1296	1323	1349	1375	1421	
	4901-5000	931	957	983	1030	1055	1081	1108	1148	1174	1201	1263	1306	1333	1359	1387	1433	

The heights of packages concern the 180° rotation.  
If TP1000K-ZF box is lowered, the total height of the product does not increase.

## EXTRA CHARGES FOR MOTORS

NAME	6 Nm	9 Nm	10 Nm	18 Nm	20 Nm
AM55 / VB55	VB55-6/22EL Included in the price	-	AM55-10/35-EL Included in the price	-	-
ELERO SOFT	JA 06 SOFT Included in the price	JA 09 SOFT Included in the price	-	-	JA 20 DK Included in the price
SOMFY WT	J406 6/24 WT 39,40 €	-	J410 10/24 WT 40,50 €	J418 18/24 WT 62,90 €	-
SOMFY WT PROTECT	J406 6/24 WT PROTECT 74,70 €	-	J410 10/24 WT PROTECT 51,90 €	J418 18/24 WT PROTECT 82 €	-
ELERO COMFORT	JA 06 COMFORT-868 131,70 €	JA 09 COMFORT-868 157,40 €	-	-	-
SOMFY RTS	J406 6/24 RTS 171,70 €	-	J410 10/24 RTS 183,20 €	J418 18/24 RTS 208,90 €	-
SOMFY IO PROTECT	J406 6/24 IO PROTECT 171,70 €	-	J410 10/24 IO PROTECT 183,20 €	J418 18/24 IO PROTECT 208,90 €	-
ELERO NHK	-	JA 09 NHK ZESTAW* 878,10 €	-	-	-

\* - Product for special order

CRANK MECHANISM (set) - 20,60 €

CRANK STEM EXTENSION - 14,20 €/m

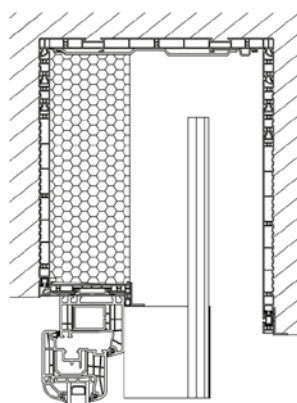

TP1000K-ZF - White  
box.

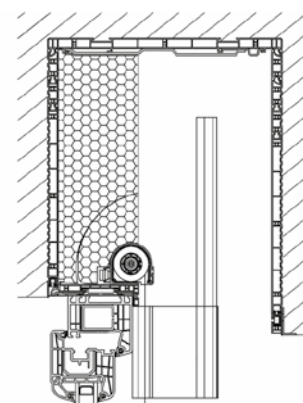

TP1000K-ZF  
with mosquito  
net - White box.

## HANDLES MOUNTING THE HEAD RAIL

4 TOP RAIL HANDLES					5 TOP RAIL HANDLES									6 TOP RAIL HANDLES				
2601-2700	2701-2800	2801-2900	2901-3000	3001-3100	3101-3200	3201-3300	3301-3400	3401-3500	3501-3600	3601-3700	3701-3800	3801-3900	3901-4000	4001-4100	4101-4200	4201-4300	4301-4400	4401-4500
899	915	930	945	970	985	1000	1041	1067	1082	1099	1114	1160	1177	1193	1210	1226	1243	1260
911	927	942	957	982	997	1013	1054	1080	1096	1112	1129	1174	1191	1207	1224	1241	1258	1275
928	945	961	976	1001	1017	1033	1074	1101	1118	1134	1151	1197	1214	1232	1249	1266	1284	1301
940	957	973	988	1013	1029	1046	1088	1114	1131	1148	1165	1211	1229	1246	1264	1281	1299	1316
951	968	985	1001	1026	1042	1059	1101	1128	1145	1162	1179	1226	1243	1261	1279	1297	1314	1332
969	986	1003	1019	1045	1062	1079	1122	1149	1167	1185	1202	1249	1267	1285	1303	1322	1340	1358
981	998	1015	1032	1058	1075	1092	1135	1163	1181	1198	1216	1263	1282	1300	1318	1337	1355	1373
992	1010	1027	1044	1070	1087	1105	1148	1177	1194	1212	1230	1277	1296	1314	1333	1352	1370	1389
1010	1027	1046	1063	1089	1107	1125	1168	1198	1216	1235	1253	1300	1319	1339	1358	1377	1396	1415
1021	1039	1057	1075	1102	1119	1138	1182	1211	1230	1249	1267	1315	1334	1353	1373	1392	1411	1431
1039	1057	1076	1094	1121	1139	1158	1202	1233	1252	1270	1289	1338	1357	1377	1397	1417	1436	1456
1050	1069	1088	1106	1134	1152	1171	1215	1246	1265	1284	1304	1352	1372	1392	1412	1432	1452	1472
1062	1081	1100	1118	1146	1165	1183	1228	1259	1279	1298	1318	1367	1387	1407	1427	1447	1467	1487
1079	1099	1118	1137	1166	1185	1204	1249	1280	1301	1321	1340	1390	1410	1431	1451	1472	1492	1513
1091	1111	1130	1150	1178	1197	1216	1262	1294	1314	1334	1355	1404	1425	1446	1467	1487	1508	1529
1109	1129	1149	1168	1197	1217	1237	1283	1315	1336	1356	1377	1427	1448	1469	1491	1512	1533	1555
1120	1141	1161	1181	1209	1242	1262	1308	1329	1349	1370	1391	1441	1462	1484	1506	1527	1548	1571
1132	1152	1173	1193	1222	1254	1275	1321	1343	1363	1384	1406	1456	1477	1499	1521	1542	1600	1622
1149	1170	1191	1212	1242	1275	1296	1342	1364	1385	1407	1428	1479	1501	1559	1581	1603	1625	1647
1161	1182	1203	1224	1254	1288	1308	1355	1377	1398	1420	1442	1493	1551	1573	1596	1618	1641	1663
1178	1200	1221	1243	1274	1307	1329	1376	1398	1420	1442	1501	1552	1575	1598	1621	1644	1666	1689
1190	1212	1233	1255	1285	1320	1342	1389	1412	1434	1492	1515	1566	1590	1612	1635	1659	1682	1705
1201	1224	1245	1267	1298	1333	1355	1403	1461	1484	1506	1529	1581	1604	1627	1650	1674	1697	1720
1219	1241	1264	1286	1317	1353	1375	1459	1482	1506	1528	1551	1604	1627	1651	1675	1699	1722	1746
1231	1253	1276	1298	1330	1366	1424	1473	1496	1519	1542	1566	1619	1642	1666	1690	1714	1738	1762
1242	1265	1288	1311	1342	1415	1437	1486	1509	1533	1556	1580	1632	1657	1680	1704	1729	1753	1777
1260	1283	1320	1379	1411	1435	1458	1507	1531	1555	1578	1602	1655	1680	1705	1729	1754	1778	
1271	1294	1368	1391	1424	1447	1471	1520	1544	1568	1593	1616	1670	1695	1720	1744	1769		
1289	1349	1386	1410	1444	1467	1491	1541	1565	1589	1614	1639	1693	1718	1743	1768			
1336	1360	1398	1423	1456	1480	1504	1554	1579	1603	1628	1653	1707	1733	1922				
1348	1372	1411	1435	1468	1493	1517	1567	1592	1618	1642	1667	1722	1911					
1365	1390	1430	1454	1488	1513	1537	1588	1614	1639	1664	1690	1908						
1377	1402	1442	1467	1501	1525	1551	1601	1627	1652	1842	1867							
1394	1420	1460	1486	1520	1546	1571	1622	1648	1838	1864								
1406	1432	1473	1498	1532	1558	1584	1635	1825	1851									
1418	1444	1485	1511	1545	1571	1597	1812	1839										
1435	1461	1503	1530	1565	1591	1781	1832											
1447	1473	1515	1542	1577	1767	1794	1846											
1465	1491	1534	1561	1761	1787	1814												
1476	1503	1546	1737	1773	1800													
1487	1514	1721	1749	1785	1813													

- BLIND MOTOR 6 Nm
- BLIND MOTOR 9 Nm
- BLIND MOTOR 10 Nm
- BLIND MOTOR 20 Nm

Minimum width (F-FBR guides) ***	574 mm
Maximum width	4500 mm
Min. width external blind with mosquito net with the use of breake	670 mm
Maximum width of mosquito net	1800 mm
Minimum width of mosquito net	605 mm
Minimum width (Crank mechanism)	520 mm

**STANDARD EQUIPMENT**

Top rail handles	F-USG
Lintel bracket of the slat profile goes with the external blinds	F-NPTK-090
Steel side handles	NPT-150
EPS foam inserts to the box sides	F-NPW-310
F-FBR-030 guide rails	F-FBR
PVC bottom end cap of the guide rail, at the client's request	
Slat rotation	90°/180°

**EXTRA CHARGE**

NAME	PRICE
Veneering guides **	8%
Varnishing guides in RAL colors *, **	20%
F-FBR-070 Double guide rail adapter	26,10 €/rm
F-FBR-080 Double guide rail distance adapter	28,10 €/rm
Box elevation by 3 cm	13,60 €/rm
Box lowering by 3 cm	2,90 €/rm
Plastering strip in the colour of the set (for colours - see page 2 of the cover)	4,00 €/rm
Automatic top rail handle F-USG-A	1,70 € / pc
Stabilising console F-NPTK-080	17,20 € / pc
Mosquito net	93,80 € / pc
F-FBD-011 Bottom alu plug of the F-FBR-010 guide	7,70 € / Pair
F-FBD-021 Bottom alu plug of the F-FBR-020 guide	7,70 € / Pair
F-FBD-031 Bottom alu plug of the F-FBR-030 guide	8,50 € / Pair
F-FBD-041 Bottom alu plug of the F-FBR-040 guide	8,50 € / Pair
F-FBD-071 Aluminium flat bottom end cap of divider guide rail F-FBR-070	6,30 € / pc
F-FBD-081 Aluminium flat bottom end cap of divider guide rail F-FBR-080	7,30 € / pc

- \* - colors other than the standard colours of the ZF3000 external blinds. In the case of little saleable RAL colors - individual valuation
- \*\* - completion date up to 21 business days
- \*\*\* - detailed table of minimum widths on p. 61

**HANDLES MOUNTING THE HEAD RAIL**

SAFETY PLATE	PACKAGE HEIGHT	h/w	2 TOP RAIL HANDLES							3 TOP RAIL HANDLES								
			600-1000	1001-1100	1101-1200	1201-1300	1301-1400	1401-1500	1501-1600	1601-1700	1701-1800	1801-1900	1901-2000	2001-2100	2101-2200	2201-2300	2301-2400	2401-2500
250	200	600-1000	648	664	678	699	714	740	754	785	800	817	833	849	865	881	897	943
		1001-1100	657	673	688	709	724	750	766	795	811	828	844	860	877	893	909	957
		1101-1200	669	685	701	721	737	764	780	811	828	844	861	877	894	911	927	975
	220	1201-1300	678	694	711	732	748	775	791	822	839	856	873	890	906	923	940	989
		1301-1400	688	704	720	742	758	785	802	832	850	867	884	902	919	936	953	1001
		1401-1500	699	716	733	754	771	799	816	848	866	883	901	919	936	954	972	1021
230	1501-1600	709	726	743	764	782	810	828	859	877	894	913	931	948	966	984	1033	
	1601-1700	718	735	752	775	792	820	838	870	888	906	924	943	961	978	997	1047	
250 + lowering or raising	250	1701-1800	729	747	765	787	806	835	853	885	903	922	941	959	978	997	1015	1065
		1801-1900	738	757	775	797	816	846	863	896	915	934	953	971	990	1009	1028	1079
250 + lowering + raising	260	1901-2000	750	769	787	811	829	860	878	911	931	950	969	989	1008	1027	1046	1098
		2001-2100	759	778	797	821	839	870	889	922	942	962	981	1000	1020	1039	1059	1111
	270	2101-2200	769	788	807	831	849	881	900	934	953	973	993	1012	1032	1052	1072	1124
		2201-2300	781	800	819	844	863	895	914	949	969	989	1009	1029	1050	1070	1090	1143
	280	2301-2400	790	809	829	854	873	905	925	959	980	1000	1021	1041	1062	1082	1102	1156
		2401-2500	802	821	842	867	887	919	940	975	996	1016	1037	1059	1079	1100	1121	1175
	300	2501-2600	811	831	852	877	910	931	951	986	1007	1028	1049	1071	1092	1125	1146	1188
		2601-2700	820	841	862	887	920	941	962	997	1019	1039	1061	1083	1104	1138	1160	1201
	310	2701-2800	832	853	874	900	934	955	976	1012	1034	1055	1077	1099	1121	1156	1178	1220
		2801-2900	841	862	883	910	944	966	987	1023	1045	1067	1089	1111	1134	1168	1191	1233
	320	2901-3000	853	874	896	923	958	980	1001	1038	1060	1083	1105	1128	1151	1187	1209	1252
		3001-3100	862	884	906	933	969	990	1013	1049	1072	1095	1117	1140	1163	1199	1222	1265
	340	3101-3200	871	893	916	943	978	1001	1023	1061	1083	1106	1129	1152	1175	1212	1235	1279
		3201-3300	883	906	928	956	992	1015	1038	1075	1099	1122	1146	1169	1192	1230	1254	1297
	350	3301-3400	892	915	938	966	1003	1026	1049	1086	1110	1134	1157	1181	1205	1243	1266	1311
		3401-3500	901	924	948	976	1013	1037	1060	1098	1122	1145	1169	1193	1217	1255	1279	1323
	370	3501-3600	913	937	960	1003	1027	1051	1075	1112	1137	1162	1186	1224	1249	1273	1298	1343
		3601-3700	923	946	970	1014	1038	1061	1085	1124	1148	1173	1197	1237	1261	1286	1310	1356
	380	3701-3800	934	958	983	1027	1051	1075	1100	1139	1164	1189	1214	1254	1279	1304	1329	1374
		3801-3900	944	968	993	1037	1061	1086	1111	1150	1175	1201	1226	1266	1291	1317	1342	1387
	400	3901-4000	953	977	1002	1047	1072	1097	1122	1161	1187	1212	1237	1278	1303	1329	1355	1401
		4001-4100	965	990	1015	1060	1085	1111	1136	1176	1202	1228	1254	1296	1321	1347	1373	1457
410	4101-4200	974	999	1025	1071	1096	1121	1147	1187	1213	1239	1266	1307	1333	1360	1386	1471	
	4201-4300	985	1011	1038	1083	1110	1136	1162	1202	1229	1255	1282	1324	1352	1378	1442	1489	
430	4301-4400	995	1021	1047	1094	1120	1146	1172	1213	1240	1267	1294	1337	1364	1428	1455	1503	
	4401-4500	1004	1030	1057	1104	1130	1157	1183	1224	1251	1279	1306	1349	1414	1441	1468	1516	
440	4501-4600	1016	1043	1070	1117	1144	1171	1198	1239	1267	1295	1322	1366	1431	1459	1486	1535	
	4601-4700	1025	1052	1079	1127	1154	1181	1209	1251	1279	1306	1334	1416	1444	1472	1499	1548	
450	4701-4800	1037	1064	1092	1140	1168	1195	1224	1265	1294	1322	1388	1433	1461	1490	1518	1567	
	4801-4900	1046	1074	1102	1151	1179	1206	1234	1277	1305	1334	1400	1445	1474	1502	1531	1580	
	4901-5000	1055	1083	1111	1161	1189	1217	1245	1288	1317	1345	1411	1457	1486	1514	1544	1593	

The heights of packages concern the 180° rotation.  
If TP1000K-ZF box is lowered, the total height of the product does not increase.

## EXTRA CHARGES FOR MOTORS

NAME	6 Nm	9 Nm	10 Nm	18 Nm	20 Nm
AM55 / VB55	VB55-6/22EL Included in the price	-	AM55-10/35-EL Included in the price	-	-
ELERO SOFT	JA 06 SOFT Included in the price	JA 09 SOFT Included in the price	-	-	JA 20 DK Included in the price
SOMFY WT	J406 6/24 WT 39,40 €	-	J410 10/24 WT 40,50 €	J418 18/24 WT 62,90 €	-
SOMFY WT PROTECT	J406 6/24 WT PROTECT 74,70 €	-	J410 10/24 WT PROTECT 51,90 €	J418 18/24 WT PROTECT 82 €	-
ELERO COMFORT	JA 06 COMFORT-868 131,70 €	JA 09 COMFORT-868 157,40 €	-	-	-
SOMFY RTS	J406 6/24 RTS 171,70 €	-	J410 10/24 RTS 183,20 €	J418 18/24 RTS 208,90 €	-
SOMFY IO PROTECT	J406 6/24 IO PROTECT 171,70 €	-	J410 10/24 IO PROTECT 183,20 €	J418 18/24 IO PROTECT 208,90 €	-
ELERO NHK	-	JA 09 NHK ZESTAW* 878,10 €	-	-	-

\* - Product for special order

CRANK MECHANISM (set) - 20,60 €

CRANK STEM EXTENSION - 14,20 €/m

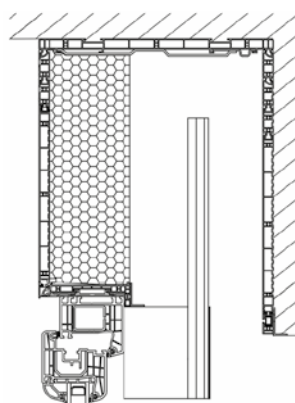

**TP1000K-ZF**  
Decor/white box.

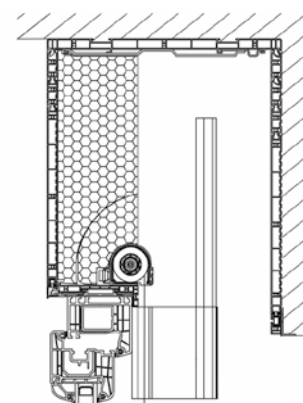

**TP1000K-ZF**  
with mosquito  
net - Decor/white box.

## HANDLES MOUNTING THE HEAD RAIL

4 TOP RAIL HANDLES					5 TOP RAIL HANDLES					6 TOP RAIL HANDLES								
2601-2700	2701-2800	2801-2900	2901-3000	3001-3100	3101-3200	3201-3300	3301-3400	3401-3500	3501-3600	3601-3700	3701-3800	3801-3900	3901-4000	4001-4100	4101-4200	4201-4300	4301-4400	4401-4500
977	994	1011	1027	1054	1070	1087	1131	1159	1176	1194	1211	1259	1278	1296	1314	1332	1351	1369
991	1008	1025	1041	1068	1085	1102	1146	1174	1192	1210	1228	1276	1295	1313	1331	1349	1368	1386
1010	1028	1046	1063	1090	1107	1125	1169	1198	1216	1234	1252	1302	1320	1339	1358	1377	1396	1415
1024	1042	1060	1077	1104	1122	1139	1184	1213	1231	1250	1268	1318	1337	1356	1375	1395	1414	1433
1037	1055	1074	1091	1119	1136	1155	1200	1229	1247	1266	1285	1334	1354	1373	1393	1412	1431	1451
1058	1076	1094	1112	1140	1159	1177	1223	1253	1272	1291	1310	1360	1380	1400	1420	1440	1460	1480
1071	1089	1109	1127	1155	1173	1192	1238	1268	1288	1307	1326	1377	1397	1417	1436	1457	1477	1497
1084	1103	1123	1141	1170	1188	1207	1253	1284	1303	1323	1343	1393	1414	1433	1454	1474	1494	1515
1104	1124	1143	1162	1191	1210	1230	1276	1308	1328	1348	1368	1419	1439	1460	1481	1501	1523	1543
1118	1138	1157	1176	1206	1225	1245	1292	1323	1344	1364	1384	1435	1456	1477	1498	1519	1540	1561
1138	1158	1178	1198	1227	1247	1268	1315	1347	1368	1389	1409	1461	1482	1504	1525	1547	1568	1590
1151	1172	1192	1212	1242	1262	1282	1330	1363	1383	1405	1426	1477	1499	1521	1542	1564	1586	1607
1165	1186	1206	1227	1256	1277	1297	1345	1378	1399	1421	1442	1494	1516	1538	1560	1582	1603	1625
1185	1206	1227	1247	1278	1299	1320	1368	1402	1424	1445	1467	1519	1542	1564	1587	1609	1631	1654
1199	1220	1241	1262	1292	1313	1334	1383	1418	1440	1461	1483	1536	1559	1581	1604	1627	1649	1672
1218	1240	1262	1283	1315	1336	1357	1406	1441	1464	1486	1508	1562	1584	1608	1631	1654	1677	1700
1231	1254	1276	1298	1329	1363	1385	1434	1457	1479	1502	1524	1578	1601	1624	1648	1671	1694	1718
1245	1267	1290	1312	1343	1378	1400	1449	1473	1495	1518	1541	1595	1618	1642	1665	1688	1750	1773
1265	1288	1311	1333	1365	1401	1423	1473	1496	1520	1543	1566	1620	1644	1706	1730	1754	1778	1802
1279	1302	1325	1347	1379	1416	1438	1488	1512	1535	1559	1582	1637	1699	1723	1747	1771	1796	1820
1298	1322	1346	1369	1402	1438	1461	1511	1535	1559	1583	1646	1700	1725	1750	1774	1799	1824	1848
1313	1336	1359	1383	1416	1453	1476	1527	1551	1575	1637	1662	1716	1742	1766	1791	1816	1841	1866
1326	1350	1373	1397	1430	1468	1491	1542	1604	1629	1653	1678	1733	1758	1783	1808	1834	1859	1884
1346	1370	1394	1418	1452	1490	1514	1603	1628	1653	1678	1702	1759	1784	1810	1835	1862	1887	1912
1359	1384	1408	1432	1467	1505	1567	1619	1644	1669	1694	1719	1775	1801	1827	1853	1879	1904	1930
1372	1397	1422	1447	1481	1558	1582	1634	1659	1685	1710	1735	1791	1817	1843	1869	1896	1922	1948
1393	1418	1458	1520	1555	1580	1605	1657	1683	1709	1735	1760	1817	1844	1870	1896	1923	1950	
1406	1431	1509	1535	1569	1595	1620	1672	1698	1724	1751	1777	1834	1861	1887	1914	1941		
1426	1490	1530	1556	1591	1617	1643	1696	1723	1749	1775	1802	1859	1887	1914	1941			
1477	1503	1544	1571	1606	1632	1658	1711	1738	1765	1791	1818	1876	1904	2102				
1491	1517	1559	1585	1620	1647	1673	1727	1753	1781	1807	1835	1892	2092					
1511	1537	1580	1606	1642	1669	1696	1750	1778	1805	1832	1860	2089						
1525	1551	1594	1621	1657	1684	1711	1765	1793	1820	2019	2047							
1544	1571	1614	1642	1679	1707	1734	1789	1817	2016	2044								
1558	1585	1629	1657	1693	1722	1749	1804	2003	2032									
1571	1599	1643	1671	1708	1736	1764	1990	2019										
1591	1620	1664	1693	1730	1759	1958	2013											
1605	1634	1678	1707	1745	1945	1973	2029											
1625	1654	1700	1728	1938	1967	1996												
1638	1668	1714	1914	1952	1982													
1652	1681	1899	1928	1967	1997													

- BLIND MOTOR 6 Nm
- BLIND MOTOR 9 Nm
- BLIND MOTOR 10 Nm
- BLIND MOTOR 20 Nm

Minimum width (F-FBR guides) ***	574 mm
Maximum width	4500 mm
Min. width external blind with mosquito net with the use of breake	670 mm
Maximum width of mosquito net	1800 mm
Minimum width of mosquito net	605 mm
Minimum width (Crank mechanism)	520 mm

**STANDARD EQUIPMENT**

Top rail handles	F-USG
Lintel bracket of the slat profile goes with the external blinds	F-NPTK-090
Steel side handles	NPT-150
EPS foam inserts to the box sides	F-NPW-310
F-FBR-030 guide rails	F-FBR
PVC bottom end cap of the guide rail, at the client's request	
Slat rotation	90°/180°

**EXTRA CHARGE**

NAME	PRICE
Veneering guides **	8%
Varnishing guides in RAL colors *, **	20%
F-FBR-070 Double guide rail adapter	26,10 €/rm
F-FBR-080 Double guide rail distance adapter	28,10 €/rm
Box elevation by 3 cm	13,60 €/rm
Box lowering by 3 cm	2,90 €/rm
Plastering strip in the colour of the set (for colours - see page 2 of the cover)	4,00 €/rm
Automatic top rail handle F-USG-A	1,70 € / pc
Stabilising console F-NPTK-080	17,20 € / pc
Mosquito net	93,80 € / pc
F-FBD-011 Bottom alu plug of the F-FBR-010 guide	7,70 € / Pair
F-FBD-021 Bottom alu plug of the F-FBR-020 guide	7,70 € / Pair
F-FBD-031 Bottom alu plug of the F-FBR-030 guide	8,50 € / Pair
F-FBD-041 Bottom alu plug of the F-FBR-040 guide	8,50 € / Pair
F-FBD-071 Aluminium flat bottom end cap of divider guide rail F-FBR-070	6,30 € / pc
F-FBD-081 Aluminium flat bottom end cap of divider guide rail F-FBR-080	7,30 € / pc

- \* - colors other than the standard colours of the ZF3000 external blinds. In the case of little saleable RAL colors - individual valuation
- \*\* - completion date up to 21 business days
- \*\*\* - detailed table of minimum widths on p. 61

**HANDLES MOUNTING THE HEAD RAIL**

SAFETY PLATE	PACKAGE HEIGHT	h/w	2 TOP RAIL HANDLES							3 TOP RAIL HANDLES								
			600-1000	1001-1100	1101-1200	1201-1300	1301-1400	1401-1500	1501-1600	1601-1700	1701-1800	1801-1900	1901-2000	2001-2100	2101-2200	2201-2300	2301-2400	2401-2500
250	200	600-1000	660	677	693	714	730	757	773	804	821	838	855	872	889	906	923	971
		1001-1100	670	686	703	724	741	768	784	815	832	849	867	884	901	919	936	984
		1101-1200	682	698	716	737	754	782	798	830	848	865	883	901	919	937	954	1003
	220	1201-1300	691	708	725	747	765	792	809	841	859	877	895	913	931	948	966	1016
		1301-1400	700	717	734	757	774	803	820	852	871	888	907	925	943	961	979	1028
		1401-1500	712	730	747	770	788	817	835	867	886	905	923	942	961	979	998	1048
230	1501-1600	721	739	757	780	798	827	846	879	897	916	935	954	973	992	1011	1061	
	1601-1700	730	748	767	790	808	838	857	890	908	928	946	966	985	1004	1023	1074	
250 + lowering or raising	250	1701-1800	742	761	780	803	822	853	871	905	924	944	963	983	1003	1022	1041	1093
		1801-1900	751	770	790	813	832	863	882	916	936	955	975	995	1014	1035	1054	1106
250 + lowering + raising	260	1901-2000	763	782	802	826	846	877	896	931	951	971	991	1012	1032	1052	1073	1125
		2001-2100	772	792	812	836	856	888	908	942	962	983	1003	1024	1045	1065	1085	1138
	270	2101-2200	781	801	821	846	866	898	918	953	974	994	1015	1036	1057	1077	1098	1152
		2201-2300	793	814	834	859	880	912	933	968	989	1010	1032	1052	1074	1095	1116	1170
	280	2301-2400	803	823	844	869	890	923	944	979	1000	1022	1043	1064	1086	1107	1129	1183
		2401-2500	814	835	856	883	903	937	958	994	1016	1038	1060	1082	1103	1125	1148	1202
	300	2501-2600	824	845	866	893	926	948	970	1006	1028	1050	1072	1094	1116	1150	1173	1215
		2601-2700	833	854	876	902	937	959	980	1016	1039	1061	1083	1106	1128	1163	1186	1228
	310	2701-2800	845	867	889	916	951	973	995	1032	1054	1077	1100	1123	1145	1181	1204	1247
		2801-2900	854	876	898	925	961	983	1005	1043	1065	1088	1112	1135	1158	1194	1217	1261
	320	2901-3000	865	888	911	938	975	997	1020	1058	1081	1104	1128	1151	1175	1212	1235	1279
		3001-3100	874	898	921	949	985	1008	1031	1069	1092	1116	1140	1164	1187	1225	1249	1293
	340	3101-3200	884	907	931	959	995	1019	1042	1080	1103	1128	1152	1176	1199	1237	1261	1306
		3201-3300	896	920	943	971	1009	1033	1057	1094	1119	1144	1168	1193	1217	1255	1280	1325
	350	3301-3400	905	929	953	981	1020	1044	1067	1106	1131	1155	1180	1204	1229	1268	1293	1338
		3401-3500	914	938	962	992	1029	1054	1078	1117	1142	1167	1192	1216	1241	1280	1305	1351
	370	3501-3600	926	951	975	1019	1043	1068	1093	1132	1157	1183	1208	1247	1273	1298	1324	1370
		3601-3700	935	960	985	1029	1054	1079	1104	1143	1169	1194	1220	1260	1286	1311	1337	1383
	380	3701-3800	947	972	997	1043	1067	1093	1118	1159	1184	1210	1236	1277	1303	1329	1356	1402
		3801-3900	956	982	1007	1052	1078	1103	1129	1169	1195	1222	1248	1290	1316	1342	1368	1415
400	3901-4000	965	991	1017	1062	1089	1114	1140	1180	1207	1233	1259	1302	1328	1355	1381	1428	
	4001-4100	977	1004	1030	1076	1102	1128	1155	1196	1223	1250	1276	1319	1346	1373	1399	1485	
410	4101-4200	987	1013	1040	1086	1113	1139	1165	1206	1234	1261	1288	1331	1358	1385	1412	1498	
	4201-4300	998	1025	1052	1099	1126	1153	1180	1222	1249	1277	1304	1348	1376	1403	1469	1517	
430	4301-4400	1007	1035	1062	1110	1136	1164	1191	1233	1261	1289	1316	1360	1388	1454	1481	1530	
	4401-4500	1016	1044	1071	1119	1147	1175	1202	1243	1272	1300	1328	1372	1438	1466	1495	1543	
440	4501-4600	1028	1057	1084	1133	1161	1189	1217	1259	1288	1316	1345	1390	1456	1484	1513	1562	
	4601-4700	1038	1066	1094	1143	1171	1199	1227	1270	1299	1327	1356	1439	1468	1497	1525	1575	
450	4701-4800	1049	1078	1106	1156	1185	1213	1242	1285	1314	1343	1411	1457	1486	1515	1544	1594	
	4801-4900	1059	1088	1116	1167	1195	1224	1253	1296	1326	1355	1422	1469	1498	1528	1557	1607	
	4901-5000	1068	1097	1126	1176	1205	1234	1264	1307	1337	1367	1434	1481	1510	1540	1570	1620	

The heights of packages concern the 180° rotation.  
If TP1000K-ZF box is lowered, the total height of the product does not increase.

## EXTRA CHARGES FOR MOTORS

NAME	6 Nm	9 Nm	10 Nm	18 Nm	20 Nm
AM55 / VB55	VB55-6/22EL Included in the price	-	AM55-10/35-EL Included in the price	-	-
ELERO SOFT	JA 06 SOFT Included in the price	JA 09 SOFT Included in the price	-	-	JA 20 DK Included in the price
SOMFY WT	J406 6/24 WT 39,40 €	-	J410 10/24 WT 40,50 €	J418 18/24 WT 62,90 €	-
SOMFY WT PROTECT	J406 6/24 WT PROTECT 74,70 €	-	J410 10/24 WT PROTECT 51,90 €	J418 18/24 WT PROTECT 82 €	-
ELERO COMFORT	JA 06 COMFORT-868 131,70 €	JA 09 COMFORT-868 157,40 €	-	-	-
SOMFY RTS	J406 6/24 RTS 171,70 €	-	J410 10/24 RTS 183,20 €	J418 18/24 RTS 208,90 €	-
SOMFY IO PROTECT	J406 6/24 IO PROTECT 171,70 €	-	J410 10/24 IO PROTECT 183,20 €	J418 18/24 IO PROTECT 208,90 €	-
ELERO NHK	-	JA 09 NHK ZESTAW* 878,10 €	-	-	-

\* - Product for special order

CRANK MECHANISM (set) - 20,60 €

CRANK STEM EXTENSION - 14,20 €/m

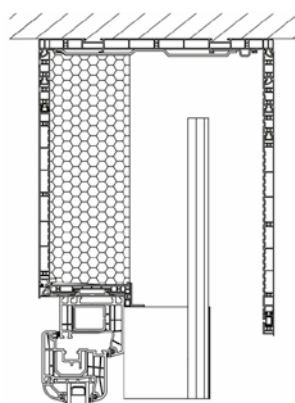

**TP1000K-ZF**  
Decor box.

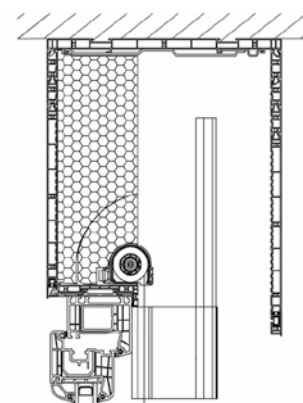

**TP1000K-ZF**  
with mosquito  
net - Decor box.

## HANDLES MOUNTING THE HEAD RAIL

4 TOP RAIL HANDLES					5 TOP RAIL HANDLES					6 TOP RAIL HANDLES								
2601-2700	2701-2800	2801-2900	2901-3000	3001-3100	3101-3200	3201-3300	3301-3400	3401-3500	3501-3600	3601-3700	3701-3800	3801-3900	3901-4000	4001-4100	4101-4200	4201-4300	4301-4400	4401-4500
1006	1024	1042	1059	1087	1104	1122	1167	1196	1214	1232	1251	1300	1320	1339	1358	1377	1396	1416
1020	1038	1056	1073	1101	1119	1137	1182	1211	1230	1249	1267	1317	1336	1355	1375	1394	1414	1433
1039	1058	1077	1095	1123	1141	1160	1205	1235	1254	1273	1292	1343	1362	1382	1402	1422	1442	1462
1053	1072	1091	1109	1137	1156	1175	1220	1250	1269	1289	1308	1359	1379	1399	1419	1439	1459	1480
1067	1085	1105	1124	1152	1170	1190	1236	1266	1285	1305	1325	1375	1396	1416	1436	1457	1477	1498
1087	1106	1126	1144	1173	1193	1212	1259	1290	1310	1330	1350	1401	1422	1443	1463	1484	1505	1526
1100	1119	1140	1159	1188	1207	1228	1274	1305	1326	1346	1366	1418	1438	1459	1480	1502	1523	1544
1113	1134	1154	1173	1203	1222	1242	1289	1321	1341	1362	1383	1434	1455	1476	1498	1519	1540	1562
1134	1154	1175	1194	1224	1244	1265	1312	1345	1366	1387	1408	1459	1481	1503	1525	1546	1569	1590
1147	1168	1189	1208	1239	1259	1280	1328	1360	1382	1403	1424	1476	1498	1520	1542	1564	1586	1608
1167	1188	1209	1230	1261	1281	1303	1351	1384	1406	1427	1449	1502	1524	1546	1569	1591	1614	1637
1180	1202	1223	1244	1275	1296	1317	1366	1400	1421	1443	1466	1518	1541	1564	1586	1609	1632	1654
1194	1216	1237	1259	1289	1310	1332	1381	1415	1437	1459	1482	1535	1558	1581	1603	1626	1649	1672
1214	1236	1258	1280	1311	1333	1355	1404	1439	1461	1484	1507	1560	1584	1607	1630	1654	1677	1700
1228	1250	1272	1294	1325	1347	1370	1420	1455	1478	1500	1523	1577	1601	1624	1648	1671	1695	1718
1247	1270	1293	1315	1347	1370	1393	1442	1478	1502	1525	1548	1603	1626	1650	1675	1698	1723	1747
1261	1284	1307	1330	1361	1397	1420	1470	1494	1517	1541	1564	1619	1643	1667	1691	1716	1740	1765
1275	1297	1321	1344	1376	1412	1436	1485	1510	1533	1557	1581	1635	1660	1685	1709	1733	1796	1820
1294	1318	1342	1365	1398	1435	1458	1509	1533	1558	1582	1606	1661	1686	1749	1774	1799	1824	1849
1308	1332	1356	1379	1412	1450	1473	1524	1549	1573	1598	1622	1678	1740	1765	1791	1816	1842	1867
1328	1352	1377	1401	1435	1472	1496	1547	1572	1597	1622	1685	1741	1767	1792	1818	1844	1869	1895
1342	1366	1391	1415	1449	1486	1511	1563	1588	1613	1676	1701	1757	1784	1809	1835	1861	1887	1913
1355	1380	1405	1429	1463	1502	1526	1578	1641	1667	1692	1717	1774	1800	1826	1852	1879	1905	1930
1375	1400	1425	1450	1485	1524	1549	1639	1665	1691	1717	1742	1800	1826	1853	1879	1906	1932	1959
1389	1414	1440	1465	1499	1539	1602	1655	1681	1706	1733	1759	1816	1843	1870	1896	1924	1950	1977
1402	1427	1454	1479	1514	1592	1618	1670	1696	1723	1749	1775	1832	1859	1886	1913	1941	1968	1995
1422	1448	1489	1552	1588	1614	1640	1693	1720	1747	1774	1800	1858	1886	1913	1940	1968	1996	
1435	1461	1540	1567	1602	1629	1655	1708	1735	1762	1790	1817	1875	1902	1930	1958	1985		
1455	1520	1561	1588	1625	1651	1678	1732	1760	1787	1814	1842	1900	1929	1956	1985			
1506	1533	1575	1603	1639	1666	1693	1747	1775	1803	1830	1858	1916	1945	2145				
1520	1547	1590	1617	1653	1681	1708	1763	1790	1819	1846	1875	1933	2133					
1540	1568	1611	1638	1676	1703	1731	1786	1815	1843	1871	1900	2130						
1554	1582	1625	1653	1690	1718	1746	1801	1830	1858	2058	2087							
1573	1602	1646	1675	1713	1741	1769	1825	1854	2054	2083								
1587	1616	1660	1689	1726	1755	1784	1840	2040	2070									
1601	1629	1674	1703	1741	1770	1799	2026	2056										
1621	1650	1695	1725	1763	1793	1993	2049											
1634	1664	1709	1739	1778	1979	2008	2065											
1654	1684	1731	1760	1971	2001	2031												
1667	1698	1745	1946	1985	2016													
1681	1711	1930	1960	2000	2031													

- BLIND MOTOR 6 Nm
- BLIND MOTOR 9 Nm
- BLIND MOTOR 10 Nm
- BLIND MOTOR 20 Nm

**EXTRA CHARGE**

Minimum width (F-FBR guides) ***	574 mm
Maximum width	4500 mm
Min. width external blind with mosquito net with the use of breake	670 mm
Maximum width of mosquito net	1800 mm
Minimum width of mosquito net	605 mm
Minimum width (Crank mechanism)	520 mm

**STANDARD EQUIPMENT**

Top rail handles	F-USG
Lintel bracket of the slat profile goes with the external blinds	F-NPTK-090
Steel side handles	NPT-150
EPS foam inserts to the box sides	F-NPW-310
F-FBR-030 guide rails	F-FBR
PVC bottom end cap of the guide rail, at the client's request	
Slat rotation	90°

NAME	PRICE
Veneering guides **	8%
Varnishing guides in RAL colors *, **	20%
F-FBR-070 Double guide rail adapter	26,10 €/rm
F-FBR-080 Double guide rail distance adapter	28,10 €/rm
Box elevation by 3 cm	13,60 €/rm
Box lowering by 3 cm	2,90 €/rm
Plastering strip in the colour of the set (for colours - see page 2 of the cover)	4,00 €/rm
Automatic top rail handle F-USG-A	1,70 €/ pc
Stabilising console F-NPTK-080	17,20 €/ pc
Mosquito net	93,80 €/ pc
F-FBD-011 Bottom alu plug of the F-FBR-010 guide	7,70 €/Pair
F-FBD-021 Bottom alu plug of the F-FBR-020 guide	7,70 €/Pair
F-FBD-031 Bottom alu plug of the F-FBR-030 guide	8,50 €/Pair
F-FBD-041 Bottom alu plug of the F-FBR-040 guide	8,50 €/Pair
F-FBD-071 Aluminium flat bottom end cap of divider guide rail F-FBR-070	6,30 €/ pc
F-FBD-081 Aluminium flat bottom end cap of divider guide rail F-FBR-080	7,30 €/ pc

\* - colors other than the standard colours of the ZF3000 external blinds. In the case of little saleable RAL colors - individual valuation  
 \*\* - completion date up to 21 business days  
 \*\*\* - detailed table of minimum widths on p. 61

**HANDLES MOUNTING THE HEAD RAIL**

SAFETY PLATE	PACKAGE HEIGHT	h/w	2 TOP RAIL HANDLES							3 TOP RAIL HANDLES								
			600-1000	1001-1100	1101-1200	1201-1300	1301-1400	1401-1500	1501-1600	1601-1700	1701-1800	1801-1900	1901-2000	2001-2100	2101-2200	2201-2300	2301-2400	2401-2500
250	160	600-1000	625	639	653	668	682	708	723	751	766	781	795	810	825	841	855	902
		1001-1100	637	651	666	681	696	724	739	768	783	798	814	829	845	860	876	924
	170	1101-1200	645	661	676	691	706	735	749	779	794	810	826	841	858	873	889	938
		1201-1300	654	669	685	700	716	745	760	790	806	822	838	854	870	886	902	952
	180	1301-1400	663	678	694	709	725	755	771	801	817	834	850	866	883	899	915	966
		1401-1500	671	688	704	719	735	766	782	812	829	845	862	879	895	911	928	979
	200	1501-1600	683	700	716	733	749	782	798	829	846	863	880	897	914	932	949	1001
		1601-1700	692	709	726	742	759	793	809	840	857	875	892	910	927	945	962	1015
	210	1701-1800	701	718	735	752	769	803	820	851	869	886	904	922	940	957	975	1029
		1801-1900	709	727	744	761	779	813	831	862	880	898	916	934	952	970	988	1043
	220	1901-2000	721	739	757	775	793	829	846	879	897	916	935	953	971	990	1009	1065
		2001-2100	730	748	767	785	803	839	858	890	909	928	947	965	984	1003	1022	1079
230	2101-2200	739	757	775	794	813	850	868	901	920	939	959	977	997	1016	1035	1093	
	2201-2300	747	766	785	804	822	860	879	912	932	951	971	990	1009	1029	1048	1106	
250 + lowering or raising	240	2301-2400	759	779	798	817	837	876	896	929	949	969	989	1009	1029	1049	1069	1128
		2401-2500	768	787	807	827	847	886	906	940	960	980	1001	1021	1042	1062	1082	1142
250 + lowering + raising	250	2501-2600	777	797	817	836	877	897	917	951	972	992	1013	1034	1054	1095	1116	1156
		2601-2700	785	806	825	846	888	908	927	962	983	1003	1025	1046	1066	1109	1130	1170
270	260	2701-2800	797	818	839	859	902	923	944	979	1000	1021	1043	1065	1086	1130	1151	1192
		2801-2900	806	827	848	869	913	934	955	990	1011	1033	1055	1077	1099	1143	1164	1206
280	270	2901-3000	815	836	857	879	923	944	965	1001	1023	1045	1067	1089	1111	1156	1178	1220
		3001-3100	823	845	867	888	934	955	977	1012	1035	1057	1079	1101	1124	1169	1191	1234
280	280	3101-3200	832	854	876	897	944	965	987	1023	1046	1068	1091	1114	1136	1183	1205	1247
		3201-3300	844	867	889	911	959	981	1003	1040	1063	1086	1109	1132	1156	1203	1226	1269
290	290	3301-3400	853	875	898	921	969	991	1014	1051	1074	1098	1121	1145	1168	1216	1240	1283
		3401-3500	862	884	907	931	979	1002	1025	1062	1086	1110	1133	1157	1181	1230	1254	1297
300	300	3501-3600	870	894	917	966	989	1013	1036	1073	1097	1121	1145	1195	1219	1244	1267	1311
		3601-3700	882	906	930	980	1004	1028	1052	1090	1114	1139	1163	1215	1239	1264	1289	1333
310	310	3701-3800	891	915	939	990	1015	1038	1063	1101	1126	1151	1175	1227	1253	1277	1302	1347
		3801-3900	900	923	948	1000	1025	1049	1074	1112	1138	1162	1187	1240	1265	1291	1316	1361
320	320	3901-4000	908	933	957	1010	1035	1060	1084	1123	1149	1174	1199	1253	1279	1304	1329	1374
		4001-4100	920	946	971	1025	1050	1075	1101	1140	1166	1192	1218	1272	1298	1325	1351	1432
330	330	4101-4200	929	954	980	1035	1061	1086	1112	1151	1177	1204	1230	1285	1312	1338	1364	1446
		4201-4300	938	963	989	1045	1071	1096	1122	1162	1189	1215	1242	1298	1325	1352	1414	1460
340	340	4301-4400	946	972	998	1055	1080	1107	1133	1173	1200	1227	1254	1311	1338	1401	1427	1474
		4401-4500	958	985	1011	1069	1096	1122	1149	1190	1217	1245	1272	1330	1394	1421	1448	1496
350	350	4501-4600	966	994	1021	1079	1106	1133	1160	1201	1229	1256	1284	1343	1406	1434	1462	1510
		4601-4700	975	1003	1030	1089	1116	1143	1171	1212	1240	1268	1296	1392	1420	1448	1475	1524
360	360	4701-4800	984	1012	1039	1099	1126	1154	1181	1223	1252	1280	1344	1405	1433	1461	1489	1537
		4801-4900	992	1020	1049	1109	1137	1165	1193	1234	1263	1292	1356	1417	1446	1474	1503	1551
370	370	4901-5000	1004	1033	1061	1123	1152	1180	1208	1251	1280	1309	1374	1437	1466	1495	1524	1573

If TP1000K-ZF box is lowered, the total height of the product does not increase.

## EXTRA CHARGES FOR MOTORS

NAME	6 Nm	9 Nm	10 Nm	18 Nm	20 Nm
AM55 / VB55	VB55-6/22EL Included in the price	-	AM55-10/35-EL Included in the price	-	-
ELERO SOFT	JA 06 SOFT Included in the price	JA 09 SOFT Included in the price	-	-	JA 20 DK Included in the price
SOMFY WT	J406 6/24 WT 39,40 €	-	J410 10/24 WT 40,50 €	J418 18/24 WT 62,90 €	-
SOMFY WT PROTECT	J406 6/24 WT PROTECT 49,20 €	-	J410 10/24 WT PROTECT 51,90 €	J418 18/24 WT PROTECT 82 €	-
ELERO COMFORT	JA 06 COMFORT-868 131,70 €	JA 09 COMFORT-868 157,40 €	-	-	-
SOMFY RTS	J406 6/24 RTS 171,70 €	-	J410 10/24 RTS 183,20 €	J418 18/24 RTS 208,90 €	-
SOMFY IO PROTECT	J406 6/24 IO PROTECT 171,70 €	-	J410 10/24 IO PROTECT 183,20 €	J418 18/24 IO PROTECT 208,90 €	-
ELERO NHK	-	JA 09 NHK ZESTAW* 878,10 €	-	-	-

\* - Product for special order

CRANK MECHANISM (set) - 20,60 €

CRANK STEM EXTENSION - 14,20 €/m

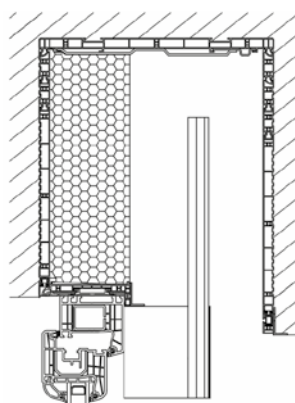

TP1000K-ZF - White  
box.

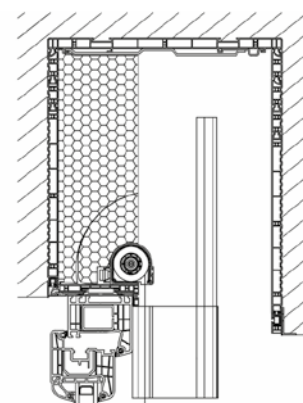

TP1000K-ZF  
with mosquito  
net - White box.

## HANDLES MOUNTING THE HEAD RAIL

4 TOP RAIL HANDLES					5 TOP RAIL HANDLES									6 TOP RAIL HANDLES				
2601-2700	2701-2800	2801-2900	2901-3000	3001-3100	3101-3200	3201-3300	3301-3400	3401-3500	3501-3600	3601-3700	3701-3800	3801-3900	3901-4000	4001-4100	4101-4200	4201-4300	4301-4400	4401-4500
934	949	965	980	1005	1021	1036	1078	1106	1123	1139	1156	1201	1218	1235	1252	1269	1286	1303
957	973	989	1005	1030	1047	1063	1105	1135	1152	1168	1186	1232	1249	1267	1284	1302	1319	1337
971	988	1004	1021	1046	1062	1079	1121	1152	1169	1186	1203	1250	1268	1286	1303	1322	1339	1357
985	1002	1019	1036	1062	1078	1095	1137	1169	1187	1204	1222	1269	1287	1304	1322	1341	1359	1377
1000	1017	1034	1051	1077	1094	1111	1154	1186	1204	1222	1240	1287	1305	1323	1342	1361	1379	1397
1014	1031	1049	1066	1093	1110	1127	1170	1204	1222	1240	1257	1305	1324	1343	1361	1380	1399	1418
1038	1055	1073	1091	1118	1136	1153	1198	1232	1251	1269	1288	1336	1355	1374	1393	1412	1432	1451
1051	1070	1088	1106	1134	1152	1170	1214	1249	1268	1287	1306	1354	1373	1393	1412	1432	1452	1471
1066	1085	1103	1122	1149	1168	1186	1230	1266	1285	1305	1323	1372	1392	1412	1432	1451	1472	1491
1081	1099	1118	1137	1165	1183	1202	1247	1283	1303	1322	1342	1391	1411	1431	1451	1471	1491	1511
1104	1123	1142	1161	1190	1209	1229	1274	1312	1332	1351	1371	1421	1442	1462	1483	1504	1524	1545
1118	1138	1157	1177	1206	1225	1244	1290	1329	1349	1369	1390	1440	1460	1481	1502	1523	1544	1565
1133	1152	1172	1192	1221	1241	1261	1306	1346	1367	1387	1408	1458	1479	1500	1522	1543	1564	1585
1147	1167	1188	1208	1237	1257	1277	1323	1363	1384	1405	1425	1476	1497	1519	1541	1562	1584	1605
1170	1191	1211	1232	1262	1283	1303	1350	1392	1413	1434	1456	1507	1529	1551	1573	1595	1617	1639
1184	1205	1227	1247	1278	1298	1320	1366	1409	1430	1452	1474	1524	1547	1569	1592	1614	1637	1659
1199	1220	1242	1263	1293	1335	1357	1404	1426	1448	1469	1492	1543	1566	1588	1611	1634	1657	1679
1214	1235	1256	1278	1309	1352	1373	1420	1443	1465	1487	1510	1561	1584	1608	1631	1653	1713	1735
1237	1259	1281	1303	1334	1378	1400	1448	1471	1494	1517	1540	1592	1616	1675	1699	1722	1746	1769
1251	1273	1296	1318	1350	1395	1417	1465	1488	1511	1535	1558	1610	1670	1694	1718	1742	1765	1789
1265	1288	1310	1333	1365	1410	1434	1482	1506	1529	1552	1612	1665	1689	1713	1737	1761	1785	1809
1280	1302	1326	1348	1381	1427	1450	1499	1523	1546	1606	1630	1683	1707	1732	1756	1781	1805	1830
1294	1318	1341	1364	1396	1444	1467	1516	1576	1600	1624	1648	1701	1726	1750	1775	1800	1825	1849
1317	1341	1365	1389	1422	1470	1494	1580	1604	1628	1653	1678	1732	1757	1782	1807	1833	1858	1883
1331	1356	1380	1404	1437	1486	1546	1596	1622	1646	1671	1696	1750	1776	1801	1827	1852	1878	1903
1346	1370	1395	1419	1453	1539	1563	1613	1639	1663	1689	1714	1768	1794	1820	1846	1872	1898	1923
1360	1385	1436	1496	1530	1555	1580	1630	1656	1681	1706	1732	1787	1813	1839	1865	1891	1918	
1383	1409	1497	1522	1557	1581	1606	1658	1684	1710	1736	1762	1817	1844	1870	1897	1924		
1398	1459	1512	1537	1572	1598	1624	1675	1701	1727	1753	1780	1836	1863	1889	1916			
1448	1474	1527	1553	1588	1614	1640	1692	1718	1744	1771	1798	1854	1881	2072				
1462	1489	1543	1569	1604	1631	1657	1709	1735	1762	1789	1816	1873	2063					
1485	1512	1567	1595	1631	1657	1684	1736	1763	1791	1819	1846	2066						
1500	1527	1583	1610	1646	1674	1700	1753	1781	1808	2000	2027							
1514	1542	1598	1626	1662	1689	1717	1770	1798	1989	2017								
1529	1556	1614	1642	1678	1706	1733	1787	1978	2007									
1552	1580	1639	1667	1704	1732	1761	1978	2007										
1566	1595	1655	1683	1720	1749	1941	1994											
1581	1609	1670	1698	1736	1929	1957	2012											
1595	1624	1685	1714	1916	1944	1974												
1610	1639	1701	1893	1932	1961													
1633	1663	1889	1918	1957	1987													

- BLIND MOTOR 6 Nm
- BLIND MOTOR 9 Nm
- BLIND MOTOR 10 Nm
- BLIND MOTOR 20 Nm

Minimum width (F-FBR guides) ***	574 mm
Maximum width	4500 mm
Min. width external blind with mosquito net with the use of breake	670 mm
Maximum width of mosquito net	1800 mm
Minimum width of mosquito net	605 mm
Minimum width (Crank mechanism)	520 mm

**STANDARD EQUIPMENT**

Top rail handles	F-USG
Lintel bracket of the slat profile goes with the external blinds	F-NPTK-090
Steel side handles	NPT-150
EPS foam inserts to the box sides	F-NPW-310
F-FBR-030 guide rails	F-FBR
PVC bottom end cap of the guide rail, at the client's request	
Slat rotation	90°

**EXTRA CHARGE**

NAME	PRICE
Veneering guides **	8%
Varnishing guides in RAL colors *, **	20%
F-FBR-070 Double guide rail adapter	26,10€/m
F-FBR-080 Double guide rail distance adapter	28,10€/m
Box elevation by 3 cm	13,60€/m
Box lowering by 3 cm	2,90€/m
Plastering strip in the colour of the set (for colours - see page 2 of the cover)	4,00€/m
Automatic top rail handle F-USG-A	1,70€/pc
Stabilising console F-NPTK-080	17,20€/pc
Mosquito net	93,80€/pc
F-FBD-011 Bottom alu plug of the F-FBR-010 guide	7,70€/Pair
F-FBD-021 Bottom alu plug of the F-FBR-020 guide	7,70€/Pair
F-FBD-031 Bottom alu plug of the F-FBR-030 guide	8,50€/Pair
F-FBD-041 Bottom alu plug of the F-FBR-040 guide	8,50€/Pair
F-FBD-071 Aluminium flat bottom end cap of divider guide rail F-FBR-070	6,30€/pc
F-FBD-081 Aluminium flat bottom end cap of divider guide rail F-FBR-080	7,30€/pc

- \* - colors other than the standard colours of the ZF3000 external blinds. In the case of little saleable RAL colors - individual valuation
- \*\* - completion date up to 21 business days
- \*\*\* - detailed table of minimum widths on p. 61

**HANDLES MOUNTING THE HEAD RAIL**

SAFETY PLATE	PACKAGE HEIGHT	h/w	2 TOP RAIL HANDLES							3 TOP RAIL HANDLES								
			600-1000	1001-1100	1101-1200	1201-1300	1301-1400	1401-1500	1501-1600	1601-1700	1701-1800	1801-1900	1901-2000	2001-2100	2101-2200	2201-2300	2301-2400	2401-2500
250	160	600-1000	675	691	706	723	738	767	783	813	830	846	862	879	895	912	928	978
		1001-1100	689	705	722	738	754	785	801	832	849	866	883	900	917	934	951	1003
	170	1101-1200	700	717	733	750	766	798	814	845	862	880	897	914	932	949	966	1019
		1201-1300	710	727	744	761	778	810	826	858	876	894	911	929	947	964	982	1035
	180	1301-1400	721	738	756	772	790	822	840	871	889	908	925	943	961	979	997	1051
		1401-1500	732	749	767	784	802	835	853	885	903	921	939	958	976	994	1012	1067
	200	1501-1600	746	764	782	800	818	853	871	904	923	941	960	978	998	1016	1035	1091
		1601-1700	756	774	793	811	829	866	884	917	936	955	974	993	1012	1031	1050	1107
	210	1701-1800	767	786	804	823	841	877	897	930	949	968	988	1007	1027	1046	1066	1123
		1801-1900	777	796	815	834	853	890	909	943	963	982	1002	1022	1041	1061	1081	1139
	220	1901-2000	791	811	831	850	869	908	927	962	982	1002	1023	1043	1063	1084	1104	1163
		2001-2100	802	822	842	862	881	920	940	975	995	1016	1037	1057	1078	1099	1119	1179
230	2101-2200	812	833	853	873	893	933	953	988	1009	1030	1051	1071	1092	1114	1135	1195	
	2201-2300	823	843	864	884	905	945	966	1001	1023	1044	1065	1086	1107	1128	1149	1212	
250 + lowering or raising	240	2301-2400	837	858	879	900	921	963	985	1020	1042	1064	1086	1108	1129	1151	1173	1236
		2401-2500	848	869	890	911	933	975	997	1033	1055	1077	1100	1122	1144	1166	1188	1252
250 + lowering + raising	250	2501-2600	858	880	902	923	966	988	1010	1046	1069	1091	1114	1136	1158	1202	1225	1268
		2601-2700	869	890	912	935	979	1001	1023	1060	1082	1104	1128	1150	1173	1218	1241	1284
270	260	2701-2800	883	905	928	950	996	1019	1041	1078	1102	1125	1148	1172	1195	1241	1265	1308
		2801-2900	893	916	939	962	1008	1031	1054	1092	1115	1139	1163	1186	1210	1257	1280	1324
280	270	2901-3000	904	927	950	973	1020	1043	1066	1104	1128	1152	1177	1200	1224	1272	1296	1340
		3001-3100	914	938	961	985	1033	1056	1080	1118	1142	1166	1191	1214	1239	1288	1311	1356
280	280	3101-3200	925	949	973	996	1045	1069	1092	1131	1155	1180	1205	1229	1253	1303	1327	1372
		3201-3300	939	963	987	1012	1062	1086	1111	1150	1175	1200	1225	1250	1275	1326	1351	1397
290	290	3301-3400	950	974	999	1023	1074	1099	1123	1163	1188	1214	1239	1265	1290	1341	1367	1413
		3401-3500	960	985	1010	1035	1086	1111	1137	1176	1202	1228	1253	1279	1305	1357	1382	1429
300	300	3501-3600	971	996	1021	1047	1099	1124	1149	1189	1215	1241	1267	1320	1346	1372	1398	1445
		3601-3700	985	1011	1037	1063	1116	1141	1167	1208	1234	1261	1288	1342	1369	1395	1422	1469
310	310	3701-3800	995	1021	1047	1073	1128	1154	1181	1221	1248	1275	1302	1357	1384	1411	1437	1485
		3801-3900	1006	1032	1058	1084	1140	1167	1193	1234	1262	1288	1316	1372	1399	1426	1454	1501
320	320	3901-4000	1016	1043	1070	1096	1153	1179	1206	1247	1275	1302	1330	1387	1414	1442	1469	1517
		4001-4100	1030	1058	1085	1112	1169	1197	1225	1267	1294	1322	1351	1408	1436	1465	1493	1579
330	330	4101-4200	1041	1068	1096	1124	1182	1210	1237	1279	1308	1336	1365	1423	1452	1481	1508	1595
		4201-4300	1052	1080	1108	1136	1194	1222	1250	1293	1321	1350	1379	1438	1467	1496	1562	1611
340	340	4301-4400	1062	1090	1118	1146	1206	1235	1263	1306	1334	1364	1392	1453	1482	1549	1577	1627
		4401-4500	1076	1105	1134	1163	1224	1252	1281	1325	1354	1384	1413	1475	1543	1572	1601	1652
350	350	4501-4600	1086	1115	1145	1174	1236	1265	1294	1338	1368	1397	1427	1490	1557	1587	1617	1668
		4601-4700	1097	1127	1156	1186	1248	1277	1307	1351	1381	1411	1441	1504	1573	1602	1633	1684
360	360	4701-4800	1107	1137	1167	1197	1260	1290	1319	1364	1395	1424	1493	1557	1588	1618	1649	1700
		4801-4900	1118	1148	1178	1208	1273	1303	1333	1377	1408	1438	1507	1572	1602	1633	1664	1716
370	370	4901-5000	1132	1163	1193	1224	1289	1320	1351	1396	1427	1459	1528	1594	1625	1657	1688	1740

If TP1000K-ZF box is lowered, the total height of the product does not increase.

## EXTRA CHARGES FOR MOTORS

NAME	6 Nm	9 Nm	10 Nm	18 Nm	20 Nm
AM55 / VB55	VB55-6/22EL Included in the price	-	AM55-10/35-EL Included in the price	-	-
ELERO SOFT	JA 06 SOFT Included in the price	JA 09 SOFT Included in the price	-	-	JA 20 DK Included in the price
SOMFY WT	J406 6/24 WT 39,40 €	-	J410 10/24 WT 40,50 €	J418 18/24 WT 62,90 €	-
SOMFY WT PROTECT	J406 6/24 WT PROTECT 49,20 €	-	J410 10/24 WT PROTECT 51,90 €	J418 18/24 WT PROTECT 82 €	-
ELERO COMFORT	JA 06 COMFORT-868 131,70 €	JA 09 COMFORT-868 157,40 €	-	-	-
SOMFY RTS	J406 6/24 RTS 171,70 €	-	J410 10/24 RTS 183,20 €	J418 18/24 RTS 208,90 €	-
SOMFY IO PROTECT	J406 6/24 IO PROTECT 171,70 €	-	J410 10/24 IO PROTECT 183,20 €	J418 18/24 IO PROTECT 208,90 €	-
ELERO NHK	-	JA 09 NHK ZESTAW* 878,10 €	-	-	-

\* - Product for special order

CRANK MECHANISM (set) - 20,60 €

CRANK STEM EXTENSION - 14,20 €/m

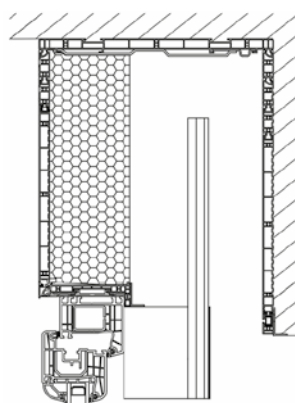

**TP1000K-ZF**  
Decor/white box.

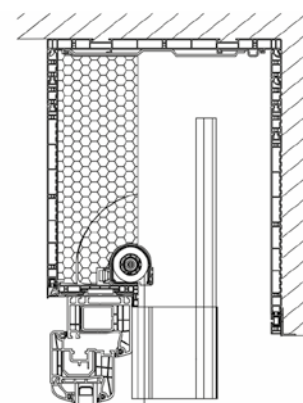

**TP1000K-ZF**  
with mosquito  
net - Decor/white box.

## HANDLES MOUNTING THE HEAD RAIL

4 TOP RAIL HANDLES					5 TOP RAIL HANDLES									6 TOP RAIL HANDLES				
2601-2700	2701-2800	2801-2900	2901-3000	3001-3100	3101-3200	3201-3300	3301-3400	3401-3500	3501-3600	3601-3700	3701-3800	3801-3900	3901-4000	4001-4100	4101-4200	4201-4300	4301-4400	4401-4500
1013	1030	1047	1064	1091	1108	1125	1170	1201	1218	1236	1255	1303	1322	1340	1359	1377	1396	1415
1039	1056	1074	1092	1119	1137	1155	1200	1232	1250	1269	1287	1336	1355	1375	1394	1413	1432	1451
1055	1073	1091	1109	1137	1154	1173	1218	1251	1270	1289	1307	1357	1376	1396	1416	1435	1455	1474
1071	1090	1108	1127	1155	1173	1191	1236	1271	1290	1309	1328	1378	1398	1417	1437	1457	1477	1497
1088	1106	1126	1144	1172	1191	1210	1255	1290	1309	1329	1348	1398	1419	1438	1458	1479	1499	1519
1105	1123	1142	1162	1190	1209	1228	1274	1309	1329	1349	1368	1419	1440	1460	1480	1501	1521	1542
1130	1150	1169	1189	1218	1238	1257	1304	1341	1361	1381	1402	1453	1473	1495	1515	1536	1558	1578
1147	1167	1187	1207	1236	1256	1276	1322	1360	1381	1401	1422	1473	1494	1516	1537	1559	1580	1601
1163	1184	1204	1224	1253	1274	1294	1341	1380	1400	1421	1442	1494	1515	1537	1559	1580	1602	1623
1180	1201	1221	1241	1271	1292	1313	1360	1399	1420	1442	1463	1515	1537	1559	1581	1602	1624	1646
1206	1227	1248	1268	1299	1320	1342	1390	1430	1452	1473	1495	1548	1571	1593	1616	1638	1660	1683
1223	1244	1265	1287	1317	1339	1360	1408	1450	1472	1494	1516	1569	1591	1614	1637	1660	1683	1705
1239	1260	1282	1304	1335	1357	1379	1427	1469	1492	1514	1536	1589	1612	1635	1659	1682	1705	1728
1255	1277	1300	1321	1353	1375	1397	1445	1489	1511	1534	1556	1610	1633	1657	1680	1704	1727	1750
1281	1303	1326	1348	1381	1403	1425	1475	1520	1543	1566	1589	1644	1667	1691	1715	1740	1764	1788
1297	1320	1343	1366	1399	1421	1444	1494	1539	1562	1586	1610	1664	1688	1712	1737	1761	1786	1810
1314	1338	1361	1383	1416	1461	1484	1535	1559	1583	1606	1630	1685	1709	1734	1759	1783	1808	1832
1331	1354	1378	1401	1434	1480	1503	1553	1578	1602	1626	1651	1705	1730	1755	1780	1805	1829	1854
1357	1381	1405	1428	1462	1509	1533	1584	1609	1634	1659	1683	1739	1765	1790	1815	1840	1865	1890
1373	1397	1422	1446	1480	1528	1552	1603	1629	1653	1679	1704	1760	1823	1849	1875	1901	1926	1952
1390	1414	1439	1463	1497	1546	1571	1623	1648	1674	1699	1762	1818	1844	1870	1896	1922	1948	1974
1406	1431	1456	1481	1516	1565	1590	1642	1668	1693	1757	1782	1839	1865	1892	1918	1944	1970	1997
1423	1448	1473	1498	1533	1584	1609	1661	1725	1751	1776	1802	1859	1886	1912	1939	1966	1993	2019
1449	1474	1500	1526	1561	1613	1639	1729	1756	1782	1808	1835	1893	1920	1947	1974	2002	2029	2057
1465	1491	1517	1543	1579	1631	1695	1748	1775	1802	1829	1855	1913	1941	1968	1996	2023	2052	2079
1481	1508	1535	1561	1597	1688	1714	1767	1795	1822	1849	1876	1934	1962	1990	2017	2045	2074	2101
1498	1525	1579	1643	1679	1706	1733	1786	1814	1842	1869	1896	1955	1983	2011	2039	2067	2096	
1524	1551	1644	1672	1708	1735	1762	1817	1845	1873	1901	1929	1988	2017	2045	2074	2103		
1540	1606	1662	1689	1726	1754	1782	1836	1864	1893	1921	1950	2009	2038	2067	2096			
1595	1622	1679	1707	1744	1773	1801	1856	1884	1913	1941	1970	2030	2059	2260				
1611	1640	1697	1725	1763	1791	1819	1875	1903	1933	1961	1990	2050	2251					
1637	1665	1724	1753	1792	1820	1849	1905	1934	1965	1994	2023	2254						
1653	1683	1742	1771	1810	1839	1868	1924	1954	1984	2185	2214							
1670	1699	1760	1789	1828	1857	1887	1943	1973	2174	2205								
1687	1716	1778	1807	1846	1876	1905	1963	2164	2195									
1712	1742	1805	1836	1875	1905	1936	2164	2195										
1728	1759	1823	1853	1893	1924	2126	2183											
1745	1776	1840	1871	1911	2114	2145	2202											
1762	1793	1858	1889	2101	2132	2163												
1779	1810	1876	2078	2119	2151													
1804	1837	2074	2106	2148	2180													

- BLIND MOTOR 6 Nm
- BLIND MOTOR 9 Nm
- BLIND MOTOR 10 Nm
- BLIND MOTOR 20 Nm

Minimum width (F-FBR guides) ***	574 mm
Maximum width	4500 mm
Min. width external blind with mosquito net with the use of breake	670 mm
Maximum width of mosquito net	1800 mm
Minimum width of mosquito net	605 mm
Minimum width (Crank mechanism)	520 mm

**STANDARD EQUIPMENT**

Top rail handles	F-USG
Lintel bracket of the slat profile goes with the external blinds	F-NPTK-090
Steel side handles	NPT-150
EPS foam inserts to the box sides	F-NPW-310
F-FBR-030 guide rails	F-FBR
PVC bottom end cap of the guide rail, at the client's request	
Slat rotation	90°

**EXTRA CHARGE**

NAME	PRICE
Veneering guides **	8%
Varnishing guides in RAL colors *, **	20%
F-FBR-070 Double guide rail adapter	26,10€/m
F-FBR-080 Double guide rail distance adapter	28,10€/m
Box elevation by 3 cm	13,60€/m
Box lowering by 3 cm	2,90€/m
Plastering strip in the colour of the set (for colours - see page 2 of the cover)	4,00€/m
Automatic top rail handle F-USG-A	1,70€ / pc
Stabilising console F-NPTK-080	17,20€ / pc
Mosquito net	93,80€ / pc
F-FBD-011 Bottom alu plug of the F-FBR-010 guide	7,70€/Pair
F-FBD-021 Bottom alu plug of the F-FBR-020 guide	7,70€/Pair
F-FBD-031 Bottom alu plug of the F-FBR-030 guide	8,50€/Pair
F-FBD-041 Bottom alu plug of the F-FBR-040 guide	8,50€/Pair
F-FBD-071 Aluminium flat bottom end cap of divider guide rail F-FBR-070	6,30€ / pc
F-FBD-081 Aluminium flat bottom end cap of divider guide rail F-FBR-080	7,30€ / pc

- \* - colors other than the standard colours of the ZF3000 external blinds. In the case of little saleable RAL colors - individual valuation
- \*\* - completion date up to 21 business days
- \*\*\* - detailed table of minimum widths on p. 61

**HANDLES MOUNTING THE HEAD RAIL**

SAFETY PLATE	PACKAGE HEIGHT	h/w	2 TOP RAIL HANDLES							3 TOP RAIL HANDLES									
			600-1000	1001-1100	1101-1200	1201-1300	1301-1400	1401-1500	1501-1600	1601-1700	1701-1800	1801-1900	1901-2000	2001-2100	2101-2200	2201-2300	2301-2400	2401-2500	
250	160	600-1000	688	704	721	738	755	784	802	833	850	868	885	902	919	937	955	1006	
		1001-1100	702	719	736	754	771	803	820	852	870	888	906	924	941	960	977	1030	
	170	1101-1200	713	730	748	766	783	815	832	865	883	902	920	938	956	974	993	1046	
		1201-1300	723	741	759	777	795	828	845	877	896	915	934	952	971	990	1008	1062	
	180	1301-1400	734	752	770	788	806	840	858	891	910	929	948	966	986	1004	1023	1078	
		1401-1500	744	763	781	799	818	852	871	904	924	942	962	981	1000	1019	1038	1094	
	200	1501-1600	758	778	796	816	835	870	889	923	943	962	982	1002	1022	1042	1061	1118	
		1601-1700	769	788	807	827	846	883	902	936	956	976	996	1016	1037	1057	1077	1134	
	210	1701-1800	779	799	819	839	858	895	915	949	970	990	1010	1030	1051	1071	1092	1150	
		1801-1900	790	810	830	850	870	908	928	962	983	1004	1024	1045	1066	1087	1107	1166	
	220	1901-2000	804	825	845	866	886	926	946	981	1002	1024	1045	1067	1087	1109	1130	1191	
		2001-2100	815	835	857	877	898	938	959	994	1016	1038	1059	1081	1102	1124	1145	1207	
230	2101-2200	825	846	867	888	910	950	972	1008	1029	1051	1073	1095	1117	1139	1161	1223		
	2201-2300	836	857	878	900	921	963	984	1020	1043	1065	1087	1109	1131	1154	1176	1239		
250 + lowering or raising	240	2301-2400	850	872	894	916	938	981	1003	1040	1063	1085	1108	1131	1154	1176	1199	1263	
		2401-2500	860	882	905	927	950	993	1016	1052	1076	1099	1122	1145	1168	1191	1214	1279	
	250	2501-2600	871	894	916	938	963	1006	1028	1066	1089	1113	1136	1160	1182	1228	1251	1295	
		2601-2700	881	904	927	950	996	1018	1041	1079	1102	1126	1150	1174	1197	1243	1267	1311	
250 + lowering + raising	270	2701-2800	895	919	942	966	1012	1036	1060	1098	1122	1146	1170	1195	1219	1267	1291	1335	
		2801-2900	906	929	953	977	1025	1048	1072	1111	1135	1160	1185	1209	1234	1282	1306	1352	
	280	2901-3000	917	941	965	989	1037	1061	1085	1124	1149	1174	1199	1224	1249	1297	1322	1368	
		3001-3100	927	951	976	1000	1050	1074	1098	1137	1163	1188	1213	1238	1263	1313	1338	1384	
	290	3101-3200	938	962	987	1011	1061	1086	1111	1150	1176	1201	1227	1253	1277	1328	1354	1400	
		3201-3300	952	977	1002	1027	1079	1104	1129	1169	1195	1222	1247	1273	1300	1351	1377	1424	
	300	3301-3400	962	988	1013	1039	1091	1116	1142	1182	1209	1235	1261	1288	1314	1366	1393	1440	
		3401-3500	973	998	1024	1051	1103	1129	1155	1195	1222	1249	1275	1302	1329	1382	1409	1456	
	310	3501-3600	983	1010	1036	1063	1115	1142	1168	1208	1235	1262	1289	1343	1370	1398	1425	1472	
		3601-3700	997	1024	1051	1105	1132	1159	1186	1227	1255	1282	1310	1366	1393	1421	1448	1496	
	320	3701-3800	1008	1035	1062	1117	1145	1172	1199	1241	1268	1296	1324	1380	1409	1436	1464	1512	
		3801-3900	1019	1046	1073	1129	1157	1184	1212	1254	1282	1310	1338	1395	1423	1451	1480	1529	
330	3901-4000	1029	1057	1084	1141	1169	1197	1224	1267	1295	1324	1352	1410	1438	1467	1495	1545		
	4001-4100	1043	1071	1100	1158	1186	1214	1243	1286	1315	1344	1373	1432	1461	1491	1519	1607		
340	4101-4200	1054	1082	1111	1170	1199	1227	1256	1299	1328	1358	1387	1447	1476	1506	1535	1623		
	4201-4300	1064	1093	1122	1182	1211	1240	1268	1312	1342	1371	1401	1462	1492	1521	1588	1639		
350	4301-4400	1074	1104	1133	1194	1223	1252	1281	1325	1355	1385	1415	1476	1506	1574	1604	1654		
	4401-4500	1089	1118	1148	1211	1240	1270	1300	1344	1374	1405	1436	1498	1567	1597	1627	1679		
360	4501-4600	1099	1129	1159	1223	1252	1282	1313	1357	1388	1419	1450	1513	1582	1612	1644	1695		
	4601-4700	1109	1140	1170	1234	1265	1295	1325	1370	1402	1433	1464	1566	1597	1628	1659	1711		
370	4701-4800	1120	1151	1182	1246	1277	1307	1338	1383	1415	1446	1515	1581	1612	1643	1675	1727		
	4801-4900	1130	1162	1193	1258	1289	1320	1351	1397	1428	1460	1529	1595	1627	1659	1690	1743		
		4901-5000	1144	1176	1208	1274	1306	1338	1369	1416	1448	1480	1550	1618	1650	1682	1714	1767	

If TP1000K-ZF box is lowered, the total height of the product does not increase.

## EXTRA CHARGES FOR MOTORS

NAME	6 Nm	9 Nm	10 Nm	18 Nm	20 Nm
AM55 / VB55	VB55-6/22EL Included in the price	-	AM55-10/35-EL Included in the price	-	-
ELERO SOFT	JA 06 SOFT Included in the price	JA 09 SOFT Included in the price	-	-	JA 20 DK Included in the price
SOMFY WT	J406 6/24 WT 39,40€	-	J410 10/24 WT 40,50€	J418 18/24 WT 62,90€	-
SOMFY WT PROTECT	J406 6/24 WT PROTECT 49,20€	-	J410 10/24 WT PROTECT 51,90€	J418 18/24 WT PROTECT 82€	-
ELERO COMFORT	JA 06 COMFORT-868 131,70€	JA 09 COMFORT-868 157,40€	-	-	-
SOMFY RTS	J406 6/24 RTS 171,70€	-	J410 10/24 RTS 183,20€	J418 18/24 RTS 208,90€	-
SOMFY IO PROTECT	J406 6/24 IO PROTECT 171,70€	-	J410 10/24 IO PROTECT 183,20€	J418 18/24 IO PROTECT 208,90€	-
ELERO NHK	-	JA 09 NHK ZESTAW* 878,10€	-	-	-

\* - Product for special order

CRANK MECHANISM (set) - 20,60€

CRANK STEM EXTENSION - 14,20€/m

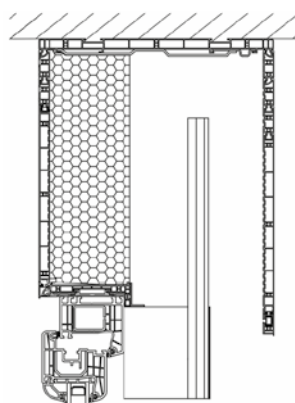

**TP1000K-ZF** -  
Decor box.

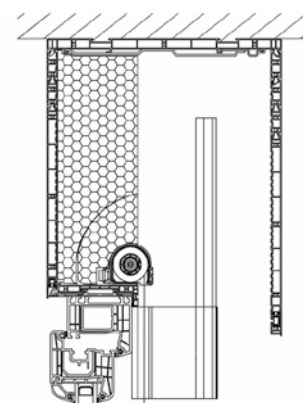

**TP1000K-ZF**  
with mosquito  
net - Decor box.

## HANDLES MOUNTING THE HEAD RAIL

4 TOP RAIL HANDLES					5 TOP RAIL HANDLES								6 TOP RAIL HANDLES					
2601-2700	2701-2800	2801-2900	2901-3000	3001-3100	3101-3200	3201-3300	3301-3400	3401-3500	3501-3600	3601-3700	3701-3800	3801-3900	3901-4000	4001-4100	4101-4200	4201-4300	4301-4400	4401-4500
1042	1060	1078	1096	1124	1142	1160	1206	1238	1256	1275	1294	1344	1364	1383	1403	1422	1442	1462
1068	1087	1105	1124	1152	1171	1190	1236	1269	1288	1307	1327	1377	1397	1418	1438	1458	1478	1498
1084	1103	1122	1141	1170	1188	1208	1254	1288	1308	1328	1347	1398	1418	1439	1459	1480	1500	1521
1101	1120	1139	1159	1188	1206	1226	1272	1308	1328	1348	1368	1419	1440	1460	1481	1502	1522	1543
1117	1137	1157	1176	1205	1225	1245	1291	1327	1347	1368	1388	1439	1461	1481	1502	1524	1545	1565
1134	1153	1174	1194	1223	1243	1263	1310	1346	1367	1388	1408	1460	1481	1503	1524	1545	1567	1588
1160	1180	1201	1221	1251	1272	1292	1340	1378	1399	1420	1442	1494	1515	1537	1559	1581	1603	1625
1176	1197	1218	1239	1269	1290	1311	1358	1397	1419	1440	1462	1514	1536	1558	1581	1603	1626	1648
1192	1214	1235	1256	1287	1308	1329	1377	1417	1438	1460	1482	1535	1557	1580	1603	1625	1648	1670
1209	1231	1252	1274	1305	1326	1347	1396	1436	1458	1480	1502	1556	1578	1601	1624	1647	1670	1692
1235	1257	1279	1301	1332	1354	1377	1426	1467	1490	1512	1535	1589	1612	1636	1660	1683	1706	1730
1252	1274	1296	1319	1351	1372	1395	1444	1487	1509	1532	1556	1610	1633	1657	1681	1705	1728	1752
1268	1291	1313	1336	1368	1391	1414	1463	1506	1530	1552	1576	1631	1654	1678	1703	1726	1750	1775
1284	1307	1331	1354	1386	1409	1432	1482	1526	1549	1573	1596	1651	1675	1700	1724	1748	1773	1797
1310	1333	1357	1381	1414	1437	1461	1511	1557	1581	1605	1629	1684	1709	1734	1759	1784	1809	1834
1327	1350	1374	1398	1432	1455	1480	1530	1576	1600	1625	1650	1704	1730	1755	1781	1806	1831	1856
1344	1368	1392	1415	1449	1495	1519	1571	1596	1621	1645	1670	1725	1751	1777	1802	1828	1854	1879
1360	1384	1409	1433	1467	1514	1538	1589	1615	1640	1665	1691	1746	1772	1798	1824	1850	1914	1939
1386	1411	1436	1460	1495	1543	1568	1620	1646	1672	1698	1723	1779	1806	1830	1856	1923	1950	1976
1402	1428	1453	1478	1513	1562	1587	1639	1666	1691	1718	1744	1800	1865	1891	1918	1945	1972	1999
1419	1444	1470	1495	1531	1580	1606	1659	1685	1712	1738	1802	1859	1886	1913	1940	1967	1994	2021
1435	1461	1487	1513	1549	1599	1625	1678	1705	1731	1755	1822	1880	1907	1934	1961	1989	2016	2044
1452	1478	1505	1530	1566	1618	1644	1697	1762	1789	1815	1842	1900	1928	1955	1983	2011	2038	2066
1478	1504	1531	1558	1594	1647	1674	1765	1793	1820	1848	1875	1934	1962	1990	2018	2046	2075	2103
1494	1521	1548	1575	1612	1665	1730	1784	1812	1840	1868	1895	1954	1983	2011	2040	2068	2097	2125
1511	1538	1566	1593	1630	1722	1749	1803	1832	1859	1888	1916	1975	2004	2033	2061	2090	2119	2148
1527	1555	1610	1675	1712	1740	1768	1822	1851	1880	1908	1936	1995	2024	2054	2083	2112	2142	
1553	1581	1675	1703	1741	1769	1797	1853	1882	1911	1940	1969	2029	2058	2088	2118	2148		
1570	1636	1693	1721	1760	1788	1817	1872	1901	1931	1960	1990	2049	2080	2110	2139			
1624	1652	1710	1739	1778	1807	1836	1892	1921	1951	1980	2010	2070	2101	2132				
1640	1670	1728	1757	1796	1825	1854	1910	1940	1971	2000	2030	2091	2123					
1666	1696	1755	1786	1825	1854	1884	1941	1971	2002	2033	2063	2126						
1683	1713	1773	1803	1843	1873	1903	1960	1991	2022	2054	2085							
1699	1730	1791	1821	1861	1891	1922	1979	2010	2042	2074								
1716	1746	1809	1839	1879	1910	1941	1999	2031	2063									
1742	1773	1836	1868	1908	1939	1971	2030											
1758	1789	1854	1885	1926	1958	1991	2051											
1774	1806	1871	1903	1944	1986	2018	2079											
1791	1824	1889	1921	1964	2006	2038												
1808	1840	1907	1940	1983	2026													
1833	1867	1935	1978	2021														

- BLIND MOTOR 6 Nm
- BLIND MOTOR 9 Nm
- BLIND MOTOR 10 Nm
- BLIND MOTOR 20 Nm

**Information on the PORTOS system boxes**

Minimum width (F-FBR guides) ***	574 mm
Maximum width	4500 mm
Min. width external blind with mosquito net with the use of breake	670 mm
Maximum width of mosquito net	1800 mm
Minimum width of mosquito net	605 mm
Minimum width (Crank mechanism)	520 mm

**STANDARD EQUIPMENT**

Top rail handles	F-USG
Lintel bracket of the slat profile goes with the external blinds	F-NPTK-090
Steel side handles	NPT-150
EPS foam inserts to the box sides	F-NPW-310

**EXTRA CHARGE**

NAME	PRICE
Veneering guides **	8%
Varnishing guides in RAL colors *, **	20%
Box elevation by 3 cm	13,60 €/m
Box lowering by 3 cm	2,90 €/m
Plastering strip in the colour of the set (for colours - see page 2 of the cover)	4,00 €/m
Automatic top rail handle F-USG-A	1,70 € / pc
Stabilising console F-NPTK-080	17,20 € / pc
Mosquito net	93,80 € / pc

- \* - colors other than the standard colours of the ZF3000 external blinds. In the case of little saleable RAL colors - individual valuation
- \*\* - completion date up to 21 business days
- \*\*\* - detailed table of minimum widths on p. 61

**HANDLES MOUNTING THE HEAD RAIL**

Safety plate/width	2 TOP RAIL HANDLES							3 TOP RAIL HANDLES								
	600-1000	1001-1100	1101-1200	1201-1300	1301-1400	1401-1500	1501-1600	1601-1700	1701-1800	1801-1900	1901-2000	2001-2100	2101-2200	2201-2300	2301-2400	2401-2500
WHITE	312	322	333	343	354	364	375	400	412	423	434	445	456	467	479	511
WHITE/DECOR	323	334	345	357	368	379	391	417	429	441	453	465	477	490	502	535
DEKOR	336	348	361	373	385	398	410	438	451	464	477	490	503	516	529	564

*If TP1000K-ZF box is lowered, the total height of the product does not increase.*

## EXTRA CHARGE

SYMBOL	NAME	PRICE
F-FBR-010	Guide adapter for external blind	17,80€/m
F-FBR-030	Guide for external blind for flush-mounted installation	21,40€/m
F-RSC-340	Insert guide for external blinds	4,00€/m
F-FBD-010	Bottom plug of the F-FBR-010 guide	0,80€/Pair
F-FBD-030	Bottom plug of the F-FBR-030 guide	0,50€/Pair
F-FBD-011	Bottom alu plug of the F-FBR-010 guide	7,70€/Pair
F-FBD-031	Bottom alu plug of the F-FBR-030 guide	8,50€/Pair

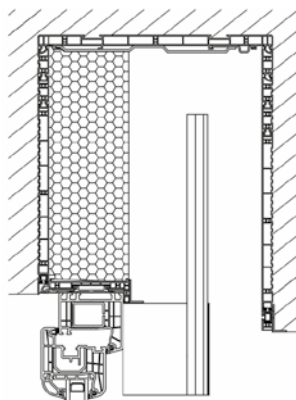

**TP1000K-ZF** - White box.

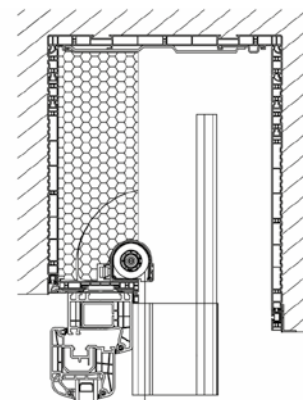

**TP1000K-ZF with mosquito net** - White box.

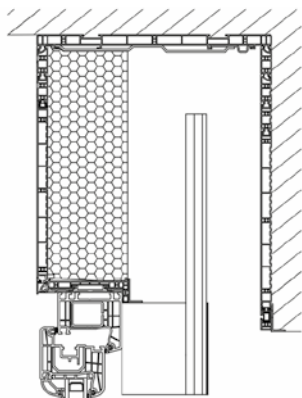

**TP1000K-ZF** - Decor/white box.

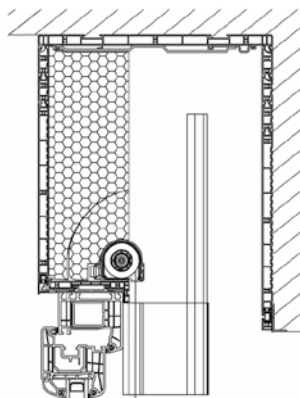

**TP1000K-ZF with mosquito net** - Decor/white box.

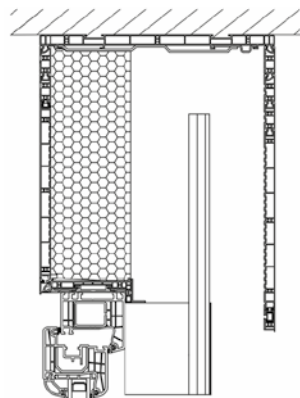

**TP1000K-ZF** - Decor box.

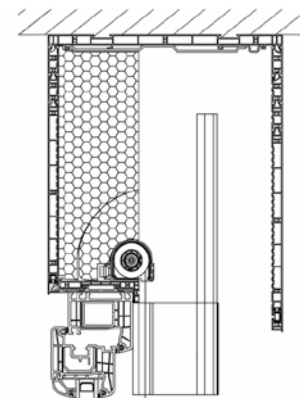

**TP1000K-ZF with mosquito net** - Decor box.

## HANDLES MOUNTING THE HEAD RAIL

4 TOP RAIL HANDLES									5 TOP RAIL HANDLES						6 TOP RAIL HANDLES				
2501-2600	2601-2700	2701-2800	2801-2900	2901-3000	3001-3100	3101-3200	3201-3300	3301-3400	3401-3500	3501-3600	3601-3700	3701-3800	3801-3900	3901-4000	4001-4100	4101-4200	4201-4300	4301-4400	4401-4500
523	535	547	559	571	583	595	607	647	660	673	686	698	743	757	770	784	797	811	824
548	561	574	587	599	612	625	638	679	693	706	720	733	779	793	808	822	836	851	865
577	591	605	619	633	647	660	674	717	731	746	760	775	822	837	853	868	883	899	914

**PR6000-HT-SINGLE**

- the price applies to a pergola in a standard colour with a tubular motor and a single-channel remote control.

**PR6000-HT-DOUBLE**

- the price applies to a pergola in a standard colour with a tubular motor and a multi-channel remote control.

**PR6000-HT-SINGLE-LED**

- the price applies to a pergola in a standard colour with a tubular motor and a multi-channel remote control, power supply and a LED controller.  
- LED lighting - alongside the pergola perimeter, warm light.

**PR6000-HT-DOUBLE-LED**

- the price applies to a pergola in a standard colour with a tubular motor and a multi-channel remote control, power supply and a LED controller.  
- LED lighting - alongside the pergola perimeter, warm light.

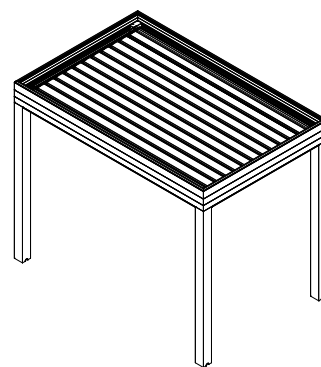

**PR6000-HT-SINGLE**

PR6000-HT-SINGLE							
outreach/ width	possible outreach	1000-2000	2001-2500	2501-3000	3001-3500	3501-4000	4001-4500
520-2500	490	7485	7485	7955	8427	8898	9369
	660						
	830						
	1000						
	1170						
	1340						
	1510						
	1680						
	1850						
	2020						
2501-3000	2190	8164	8164	8702	9241	9779	10317
	2360						
	2530						
3001-3500	2700	8776	8776	9375	9973	10572	11171
	2870						
	3040						
3501-4000	3210	9387	9387	10047	10706	11365	12024
	3380						
	3550						
	3720						
	3890						

PR6000-HT-DOUBLE							
outreach/ width	possible outreach	1000-2000	2001-2500	2501-3000	3001-3500	3501-4000	4001-4500
880-2500	880	8110	8110	8622	9136	9649	10162
	1050						
	1220						
	1390						
	1560						
	1730						
	1900						
	2070						
	2240						
	2410						
2501-3000	2580	8789	8789	9369	10120	10530	11110
	2750						
	2920						
3001-3500	3090	9448	9448	10094	10739	11384	12030
	3260						
	3430						
3501-4000	3600	10108	10108	10818	11529	12239	12949
	3770						
	3940						
4001-4500	4110	10767	10767	11542	12318	13093	13869
	4280						
	4450						
4501-5000	4620	11426	11426	12267	13107	13948	14789
	4790						
	4960						
5001-5500	5130	12086	12086	13191	14266	14803	15709
	5300						
	5470						
5501-6000	5640	12745	12745	13715	14861	15657	16628
	5810						
	5980						
6001-6500	6150	13405	13480	14640	15947	16511	17548
	6320						
	6490						
6501-7000	6660	14064	14064	15289	16664	17366	18468
	6830						
	7000						

## EXTRA CHARGE

NAME	PRICE
Gutter elevating profile	49,50 € / m
Varnishing - RAL colours *, **	10%
GIRO LUX BLUE remote control, 7+1 channels ***	31,50 € / pc
WINDTEC LUX Wind and sun sensor	163,60 € / pc
RUGIADA Rain sensor	318,10 € / pc
POWER ONE 2M Receiver	185,40 € / pc

\* - colours outside of the basic colour palette for a PR6000 pergola. In case of unusual RAL colours - individual pricing

\*\* - completion up to 21 business days

\*\*\* - surcharge applies only if a remote control is purchased (an option) with the PR6000-HT-SINGLE pergola

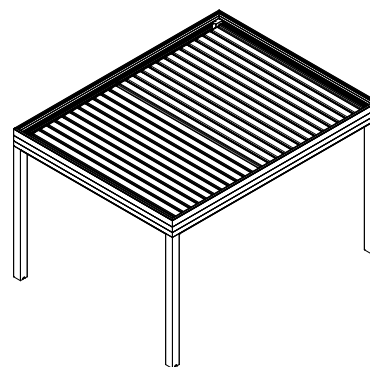

**PR6000-HT-DOUBLE**

		PR6000-HT-SINGLE LED					
outreach/ width	possible outreach	1000-2000	2001-2500	2501-3000	3001-3500	3501-4000	4001-4500
520-2500	490	8268	8268	8738	9210	9681	10152
	660						
	830						
	1000						
	1170						
	1340						
	1510						
	1680						
	1850						
	2020						
2501-3000	2190	8947	8947	9485	10024	10562	11100
	2360						
	2530						
3001-3500	2700	9559	9559	10158	10756	11355	11954
	2870						
	3040						
	3210						
3501-4000	3380	10170	10170	10830	11489	12148	12807
	3550						
	3720						
	3890						

		PR6000-HT-DOUBLE LED					
outreach/ width	possible outreach	1000-2000	2001-2500	2501-3000	3001-3500	3501-4000	4001-4500
880-2500	880	8954	8 954,00	9466	9980	10493	11006
	1050						
	1220						
	1390						
	1560						
	1730						
	1900						
	2070						
	2240						
	2410						
2501-3000	2580	9633	9633	10213	10964	11374	11954
	2750						
	2920						
3001-3500	3090	10292	10292	10938	11583	12228	12874
	3260						
	3430						
	3600						
3501-4000	3770	10952	10952	11662	12373	13083	13793
	3940						
	4110						
4001-4500	4280	11611	11611	12386	13162	13937	14713
	4450						
	4620						
4501-5000	4790	12270	12270	13111	13951	14792	15633
	4960						
	5130						
5001-5500	5300	12930	12930	14035	15110	15647	16553
	5470						
	5640						
5501-6000	5810	13589	13589	14559	15705	16501	17472
	5980						
	6150						
6001-6500	6320	14249	14324	15484	16791	17355	18392
	6490						
	6660						
	6830						
6501-7000	7000	14908	14908	16133	17508	18210	19312
	6660						
	6830						

**PR6000-LITE**

- the price applies to a pergola in a standard colour, with a linear motor and Somfy IO Situo 5 VARA/M io pure II remote control.

**PR6000-LITE-LED**

- the price applies to a pergola in a standard colour, with a linear motor and IO Situo 5 VARA/M io pure II remote control, power supply and Somfy LED receiver IO controller.

- LED lighting - alongside the pergola perimeter, warm light.

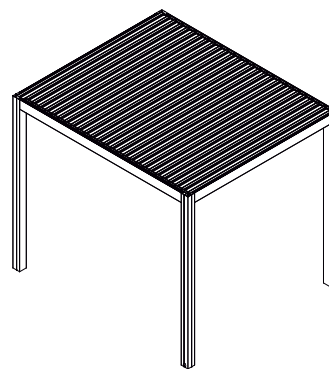

**PR6000 LITE**

**EXTRA CHARGE**

NAME	PRICE
Varnishing - RAL colours *, **	10%
Eolis 230V wind sensor (wireless)	185,10 € / Stk.
Soliris io sun and wind sensor 230V (wireless)	241,70 € / Stk.
Sunis WireFree II io sun sensor	132,30 € / Stk.
Ondeis rain sensor 230V	356,60 € / Stk.

\* - colours outside of the basic colour palette for a PR6000 pergola.

In case of unusual RAL colours - individual pricing.

\*\* - order fulfilment up to 21 business days.

PR6000 LITE		
outreach/ width	3000	3500
3000	6 032	6 372
3524	6 469	6 857
4048	6 906	7 343

PR6000 LITE LED		
outreach/ width	3000	3500
3000	7 358	7 708
3524	7 805	8 203
4048	8 252	8 698

maximum height PR6000 LITE - 2600 mm

Minimum width of the mosquito net	500 mm
Maximum width of the mosquito net	2400 mm
Maximum width of the double mosquito net	3600 mm
Minimum height of the mosquito net	1900 mm
Maximum height of the mosquito net	2600 mm

**STANDARD EQUIPMENT**

Colour of the mosquito net profile: silver(01), white(02), grey(03), beige(05), light grey (07), dark brown(08), brown(09), ivory(16), black (20), anthracite grey (23) \*  
 Net colour black

**EXTRA CHARGE**

NAME	PRICE
Varnishing of mosquito net profiles	
- colours of the basic colour palette ZF3000	5%
- colour palette for roller shutters - dark beige (04), green (13), cream white (15), claret (19), steel olive (26), basalt grey (27)	5%
- other RAL colours **	10%

\* - basic colour palette available for PORTOS catalogue roller shutters

\*\* - order fulfilment up to 21 business days



**Pleated mosquito net Single**



**Pleated mosquito net Double**

Measurements are taken by measuring the width and height of the window recess at least in three points. If the measurements differ in several points, in the order - state the lowest value.

		SINGLE PLEATED MOSQUITO NET - INTEGRATED			
width \ height		500-1200	1201-1500	1501-1800	1801-2400
1900-2200		449	476	493	563
2201-2600		480	511	532	610

For PORTOS external roller shutter systems

		DOUBLE PLEATED MOSQUITO NET - INTEGRATED						
width \ height		500-1200	1201-1500	1501-1800	1801-2400	2401-2500	2501-3000	3001-3600
1900-2200		691	695	699	737	739	800	843
2201-2600		709	712	717	755	756	817	861

For PORTOS external roller shutter systems

		SINGLE PLEATED MOSQUITO NET - INDEPENDENT			
width \ height		500-1200	1201-1500	1501-1800	1801-2400
1900-2200		501	529	549	623
2201-2600		537	569	593	675

For PORTOS external blind systems and installation on the façade

		DOUBLE PLEATED MOSQUITO NET - INDEPENDENT						
width \ height		500-1200	1201-1500	1501-1800	1801-2400	2401-2500	2501-3000	3001-3600
1900-2200		743	748	755	797	799	864	912
2201-2600		765	771	778	820	822	886	934



For PORTOS external blind systems and installation on the façade

# ZF3000 EXTERNAL BLIND

## PRICE LIST OF SAFETY PLATES FOR F-PP GUIDE

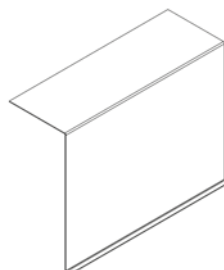
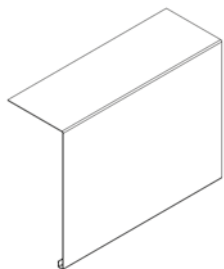
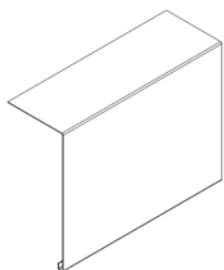
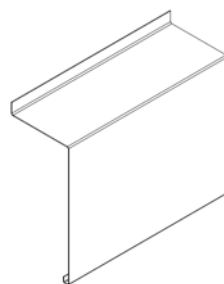
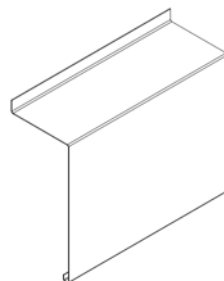
Symbol	Name	Price
F-B15A-12-20	Safety plate 200 mm, Type A to C80	31,90 €/rm
F-B15A-12-25	Safety plate 250 mm, Type A to C80	36,20 €/rm
F-B15A-12-30	Safety plate 300 mm, Type A to C80	40,40 €/rm
F-B15A-12-34	Safety plate 340 mm, Type A to C80	43,90 €/rm
F-B15A-12-37	Safety plate 370 mm, Type A to C80	46,60 €/rm
F-B15A-12-44	Safety plate 440 mm, Type A to C80	52,60 €/rm
F-B15A-12-48	Safety plate 480 mm, Type A to C80	56,00 €/rm
F-B15A-14-20	Safety plate 200 mm, Type A to Z90	33,60 €/rm
F-B15A-14-25	Safety plate 250 mm, Type A to Z90	37,90 €/rm
F-B15A-14-30	Safety plate 300 mm, Type A to Z90	42,20 €/rm
F-B15A-14-34	Safety plate 340 mm, Type A to Z90	45,60 €/rm
F-B15A-14-37	Safety plate 370 mm, Type A to Z90	48,30 €/rm
F-B15B-12-20	Safety plate 200 mm, Type B to C80	30,20 €/rm
F-B15B-12-25	Safety plate 250 mm, Type B to C80	34,40 €/rm
F-B15B-12-30	Safety plate 300 mm, Type B to C80	38,70 €/rm
F-B15B-12-34	Safety plate 340 mm, Type B to C80	42,20 €/rm
F-B15B-12-37	Safety plate 370 mm, Type B to C80	44,90 €/rm
F-B15B-12-44	Safety plate 440 mm, Type B to C80	50,90 €/rm
F-B15B-12-48	Safety plate 480 mm, Type B to C80	54,30 €/rm
F-B15B-14-20	Safety plate 200 mm, Type B to Z90	31,90 €/rm
F-B15B-14-25	Safety plate 250 mm, Type B to Z90	36,20 €/rm
F-B15B-14-30	Safety plate 300 mm, Type B to Z90	40,40 €/rm
F-B15B-14-34	Safety plate 340 mm, Type B to Z90	43,90 €/rm
F-B15B-14-37	Safety plate 370 mm, Type B to Z90	46,60 €/rm
F-B15C-12-20	Safety plate 200 mm, Type C to C80	30,20 €/rm
F-B15C-12-25	Safety plate 250 mm, Type C to C80	34,40 €/rm
F-B15C-12-30	Safety plate 300 mm, Type C to C80	38,70 €/rm
F-B15C-12-34	Safety plate 340 mm, Type C to C80	42,20 €/rm
F-B15C-12-37	Safety plate 370 mm, Type C to C80	44,90 €/rm
F-B15C-12-44	Safety plate 440 mm, Type C to C80	50,90 €/rm
F-B15C-12-48	Safety plate 480 mm, Type C to C80	54,30 €/rm

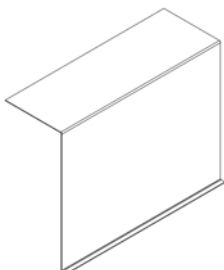
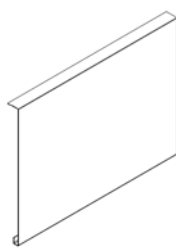

Symbol	Name	Price			
F-B15C-14-20	Safety plate 200 mm, Type C to Z90	31,90 €/rm			
F-B15C-14-25	Safety plate 250 mm, Type C to Z90	36,20 €/rm			
F-B15C-14-30	Safety plate 300 mm, Type C to Z90	40,40 €/rm			
F-B15C-14-34	Safety plate 340 mm, Type C to Z90	43,90 €/rm			
F-B15C-14-37	Safety plate 370 mm, Type C to Z90	46,60 €/rm			
					
			F-B15D-20	Safety plate 200 mm, Type D to C80, Z90	20,60 €/rm
			F-B15D-25	Safety plate 250 mm, Type D to C80, Z90	24,90 €/rm
			F-B15D-30	Safety plate 300 mm, Type D to C80, Z90	29,20 €/rm
			F-B15D-34	Safety plate 340 mm, Type D to C80, Z90	32,60 €/rm
			F-B15D-37	Safety plate 370 mm, Type D to C80, Z90	35,30 €/rm
			F-B15D-44	Safety plate 440 mm, Type D to C80, Z90	41,30 €/rm
F-B15D-48	Safety plate 480 mm, Type D to C80, Z90	44,70 €/rm			
					
			F-ZBB-12-20	Side end cap for C80 safety plate 200 mm	10,60 €/Pair
			F-ZBB-12-25	Side end cap for C80 safety plate 250 mm	13,10 €/Pair
			F-ZBB-12-30	Side end cap for C80 safety plate 300 mm	15,40 €/Pair
			F-ZBB-12-34	Side end cap for C80 safety plate 340 mm	17,20 €/Pair
			F-ZBB-12-37	Side end cap for C80 safety plate 370 mm	18,70 €/Pair
			F-ZBB-12-44	Side end cap for C80 safety plate 440 mm	22,00 €/Pair
			F-ZBB-12-48	Side end cap for C80 safety plate 480 mm	24,00 €/Pair
					
			F-ZBB-14-20	Side end cap for Z90 safety plate 200 mm	11,90 €/Pair
			F-ZBB-14-25	Side end cap for Z90 safety plate 250 mm	14,60 €/Pair
			F-ZBB-14-30	Side end cap for Z90 safety plate 300 mm	17,20 €/Pair
			F-ZBB-14-34	Side end cap for Z90 safety plate 340 mm	19,40 €/Pair
F-ZBB-14-37	Side end cap for Z90 safety plate 370 mm	21,00 €/Pair			
F-LB-12-20/25/30	C80 safety plate connector	5,00 €/Pcs.			
F-LB-12-34/37/44/48	C80 safety plate connector	7,10 €/Pcs.			
F-LB-14-20/25/30	Z90 safety plate connector	5,30 €/Pcs.			
F-LB-14-34/37	Z90 safety plate connector	6,00 €/Pcs.			
F-LB-15-20/25/30	C80, Z90 safety plate connector for FB15A/B/C-15	6,20 €/Pcs.			
F-LB-15-34/37/44/48	C80, Z90 safety plate connector for FB15A/B/C-15	8,50 €/Pcs.			
F-LB-20/25/30	Safety plate connector for type D	5,90 €/Pcs.			
F-LB-34/37/44/48	Safety plate connector for type D	8,00 €/Pcs.			

The maximum width of the cover in one piece without joints: 5,00 m.

Extra charge for a 2 mm thick safety plate is 30% of the value of covers from the table. The standard thickness of the safety plate is 1.5 mm (surcharges are not cumulative).

Varnishing of safety plates in RAL colours – with 30% extra charge on price list.

As a standard, safety plates are varnished from the outside. Varnishing from the inside on an individual order.

Extra charge for double-sided varnishing is 15% of the value of covers from the above price list.

When purchasing safety plates, the cost of safety plate extensions must be added. The number of extensions in the blinds corresponds to the number of top rail handles.

# ZF3000 EXTERNAL BLIND

## PRICE LIST OF SAFETY PLATES FOR F-FBR GUIDE

Symbol	Name	Price
F-B15A-15-20	Safety plate 200 mm, Typ A to C80, Z90 FBR	34,40 €/rm
F-B15A-15-25	Safety plate 250 mm, Typ A to C80, Z90 FBR	38,70 €/rm
F-B15A-15-30	Safety plate 300 mm, Typ A to C80, Z90 FBR	43,00 €/rm
F-B15A-15-34	Safety plate 340 mm, Typ A to C80, Z90 FBR	46,30 €/rm
F-B15A-15-37	Safety plate 370 mm, Typ A to C80, Z90 FBR	49,10 €/rm
F-B15A-15-44	Safety plate 440 mm, Typ A to C80, Z90 FBR	55,10 €/rm
F-B15A-15-48	Safety plate 480 mm, Typ A to C80, Z90 FBR	58,60 €/rm

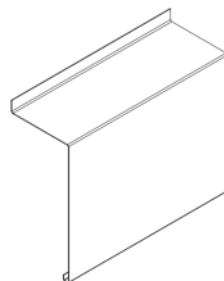

F-B15B-15-20	Safety plate 200 mm, Typ B to C80, Z90 FBR	32,70 €/rm
F-B15B-15-25	Safety plate 250 mm, Typ B to C80, Z90 FBR	37,00 €/rm
F-B15B-15-30	Safety plate 300 mm, Typ B to C80, Z90 FBR	41,30 €/rm
F-B15B-15-34	Safety plate 340 mm, Typ B to C80, Z90 FBR	44,70 €/rm
F-B15B-15-37	Safety plate 370 mm, Typ B to C80, Z90 FBR	47,40 €/rm
F-B15B-15-44	Safety plate 440 mm, Typ B to C80, Z90 FBR	53,40 €/rm
F-B15B-15-48	Safety plate 480 mm, Typ B to C80, Z90 FBR	56,90 €/rm

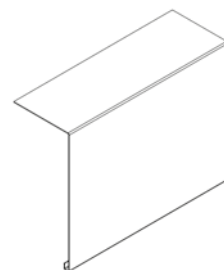

F-B15C-15-20	Safety plate 200 mm, Typ C to C80, Z90 FBR	32,70 €/rm
F-B15C-15-25	Safety plate 250 mm, Typ C to C80, Z90 FBR	37,00 €/rm
F-B15C-15-30	Safety plate 300 mm, Typ C to C80, Z90 FBR	41,30 €/rm
F-B15C-15-34	Safety plate 340 mm, Typ C to C80, Z90 FBR	44,70 €/rm
F-B15C-15-37	Safety plate 370 mm, Typ C to C80, Z90 FBR	47,40 €/rm
F-B15C-15-44	Safety plate 440 mm, Typ C to C80, Z90 FBR	53,40 €/rm
F-B15C-15-48	Safety plate 480 mm, Typ C to C80, Z90 FBR	56,90 €/rm

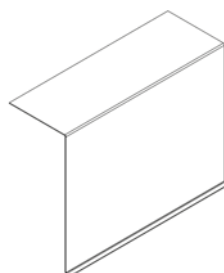

F-B15E-20	Safety plate 200 mm, Typ E to C80, Z90 FBR	20,20 €/rm
F-B15E-25	Safety plate 250 mm, Typ E to C80, Z90 FBR	24,50 €/rm
F-B15E-30	Safety plate 300 mm, Typ E to C80, Z90 FBR	28,80 €/rm
F-B15E-34	Safety plate 340 mm, Typ E to C80, Z90 FBR	32,20 €/rm
F-B15E-37	Safety plate 370 mm, Typ E to C80, Z90 FBR	34,90 €/rm
F-B15E-44	Safety plate 440 mm, Typ E to C80, Z90 FBR	40,90 €/rm
F-B15E-48	Safety plate 480 mm, Typ E to C80, Z90 FBR	44,40 €/rm

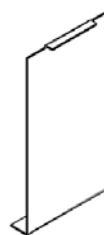

Symbol	Name	Price
F-ZBB-15-20	Side end cap for C80, Z90 safety plate 200 mm FBR	9,90 €/Pair
F-ZBB-15-25	Side end cap for C80, Z90 safety plate 250 mm FBR	12,20 €/Pair
F-ZBB-15-30	Side end cap for C80, Z90 safety plate 300 mm FBR	14,40 €/Pair
F-ZBB-15-34	Side end cap for C80, Z90 safety plate 340 mm FBR	16,20 €/Pair
F-ZBB-15-37	Side end cap for C80, Z90 safety plate 370 mm FBR	17,50 €/Pair
F-ZBB-15-44	Side end cap for C80, Z90 safety plate 440 mm FBR	20,60 €/Pair
F-ZBB-15-48	Side end cap for C80, Z90 safety plate 480 mm FBR	22,30 €/Pair
F-LB-15-20/25/30	Safety plate connector 200/250/300 mm to C80, Z90 FBR	6,20 €/Pcs.
F-LB-15-34/37/44/48	Safety plate connector 340/370/440/480 mm to C80, Z90 FBR	8,50 €/Pcs.

The maximum width of the cover in one piece without joints: 5,00 m.

Extra charge for a 2 mm thick safety plate is 30% of the value of covers from the table. The standard thickness of the safety plate is 1.5 mm (surcharges are not cumulative).

Varnishing of safety plates in RAL colours – with 30% extra charge on price list.

As a standard, safety plates are varnished from the outside. Varnishing from the inside on an individual order.

Extra charge for double-sided varnishing is 15% of the value of covers from the above price list.

When purchasing safety plates, the cost of safety plate extensions must be added. The number of extensions in the blinds corresponds to the number of top rail handles.

# ZF3000 EXTERNAL BLIND

## PRICE LIST OF ADDITIONAL COMPONENTS

F-US-120	Wall handle 120 mm	5,30 €
F-US-140	Wall handle 140 mm	5,60 €
F-USG	Top rail handle	2,40 €
F-USG - A	Automatic top rail handle	3,30 €
F-US-100-150	Adjustable wall handle size 100-150 mm	13,50 €
F-US-150-200	Adjustable wall handle size 150-200 mm	14,80 €
F-US-200-250	Adjustable wall handle size 200-250 mm	16,00 €
F-PBO-126 + F-WP-45	Safety plate extension 126 mm for sheets 130-173 mm Extension silencing element (set)	4,60 €
F-PBO-143 + F-WP-45	Safety plate extension 143 mm for sheets 174-253 mm Extension silencing element (set)	4,20 €
F-PBO-223 + F-WP-45	Safety plate extension 223 mm for sheets 254-330 mm Extension silencing element (set)	5,40 €
F-PBO-303 + F-WP-45	Safety plate extension 303 mm for sheets 331-412 mm Extension silencing element (set)	7,40 €
F-PBO-383 + F-WP-45	Safety plate extension 383 mm for sheets 413-480 mm Extension silencing element (set)	8,90 €
F-UPP-50-70	Straight guide handle 50-70 mm	4,70 €
F-UPP-71-100	Straight guide handle 71-100 mm	5,60 €
F-UPP-101-145	Straight guide handle 101-145 mm	6,50 €
F-UPT-50-70	Telescopic guide handle 50-70 mm	9,30 €
F-UPT-71-105	Telescopic guide handle 71-105 mm	11,60 €
F-UPT-106-170	Telescopic guide handle 106-170 mm	14,90 €
F-UPT-171-295	Telescopic guide handle 171-295 mm	19,90 €
F-UPU-25	Universal telescopic guide handle 25 (50-60 mm)	6,00 €
F-UPU-35	Universal telescopic guide handle 35 (60-70 mm)	6,20 €
F-UPU-45	Universal telescopic guide handle 45 (70-90 mm)	6,60 €
F-UPU-65	Universal telescopic guide handle 65 (90-130 mm)	7,10 €
F-UDPL-80	Cord guide lower handle 80 mm	6,60 €
F-UDPL-120	Cord guide lower handle 120 mm	8,00 €
F-UDPL-150	Cord guide lower handle 150 mm	8,40 €
F-UDPP	Cord guide lower handle attached to the floor	7,50 €
F-WN	Drive shaft connector	28,20 €
MAQ-10	Thermal insulation mat aluthermo quattro	70,00 €/rm
F-UPN 60-70	60-70mm corner guide handle	22,70 €
F-UPN 70-80	70-80mm corner guide handle	22,70 €
F-UPN 80-100	80-100mm corner guide handle	23,70 €
F-UPNW-75-100	75-100mm corner internal guide handle	25,00 €
F-UPNW-95-140	95-140mm corner internal guide handle	27,00 €
F-PN	Corner profile to ZF3000-BX	16,20 €/rm
F-PN-OKL	Corner profile to ZF3000-BX veneered	22,30 €/rm



# ZF3000 EXTERNAL BLIND

## PRICE LIST OF CONTROL ELEMENTS



### RADIO CONTROL RTS

#### WALL TRANSMITTERS SMOOVE RTS

1810881	Smoove 1 RTS Pure shine	67,60 €
1810882	Smoove 1 RTS Black shine	67,60 €
1810883	Smoove 1 RTS Silver shine	65,00 €

#### SMOOVE FRAMES

9015022	Smoove Pure frame	5,10 €
9015023	Smoove Black frame	12,30 €
9015238	Smoove Pure frame - double	9,50 €

#### RTS REMOTES WITH SOLAR AUTOMATIC OPERATION

1870435	Situo 1 Soliris RTS Pure II EE	122,40 €
1870438	Situo 5 Soliris RTS Pure II EE	122,60 €
1800503	Situo VAR Soliris RTS Pure II <b>NEW</b>	122,60 €

#### RTS REMOTES WITH BUILT-IN TIMER

1805215	Telis 6 Chronis RTS Pure	253,50 €
1805216	Telis 6 Chronis RTS Silver	280,70 €

#### RTS MOD/VAR REMOTES WITH A SCROLL WHEEL

1811610	Situo 5 Var RTS Pure II * <b>NEW</b>	112,60 €
1811611	Situo 5 Var RTS Iron II * <b>NEW</b>	185,80 €
1811608	Situo 1 Var RTS Pure II ** <b>NEW</b>	86,10 €
1811609	Situo 1 Var RTS Iron II ** <b>NEW</b>	100,90 €

#### MOD/VAR RTS RECEIVERS FOR INSTALLATION IN THE BLIND RAIL 50 mm (SLAT ROTATION FUNCTION)

1810802	Mod/ Var Slim Receiver RTS with Hirschmann female plugs	155,10 €
---------	---	----------

#### RTS WEATHER CONTROL SYSTEM - SENSORS

1816066	Eolis Sensor RTS radio wind sensor with LED indicator, 230V	116,70 €
1818210	Soliris Sensor RTS radio solar-wind sensor, power supply ~230V	163,30 €
1818225	Soliris Sensor RTS Regenoption - adapted to the rain sensor, 230V	538,20 €
9016345	Ondeis 230V rain sensor	494,50 €
9013075	Sunis WireFree RTS - sun sensor, 230V	370,90 €

#### MOUNTING CABLE

9015971	Universal mounting cable io/RTS/WT/LT/LS/Solus/J4 - Somfigurator	157,70 €
266181501	Cable extension for external blinds motors 5m.	41,90 €

#### CABLE CONTROL

1800510	Somfy Smoove Uno VB	23,00 €
1800505	Somfy Smoove Duo VB	36,70 €

\* - Device replaces previous Telis 4 MOD/VAR RTS remotes

\*\* - Device replaces previous Telis 1 MOD/VAR RTS remotes



## IO-HOMECONTROL

### io-homecontrol® - HOME CONTROL BY THE INTERNET

1870594	TaHoma® Switch - Central control unit for io, RTS, RTD	393,00 €
---------	--	----------

### io TRANSMITTERS

1805228	Chronis io - weekly timer	171,70 €
---------	---------------------------	----------

### io-homecontrol® COMPUTER INSTALLATION PROGRAMMER

9017035	Set&Go io - installation tool for io system	296,10 €
---------	---	----------

### io-homecontrol® - NINA GROUP CONTROL REMOTES AND REMOTES WITH TIMER CONTROL

1805251	Nina io - individual and group control	282,00 €
---------	--	----------

1811407	NiNa Timer - individual, group control and timer control	294,00 €
---------	--	----------

### io-homecontrol® - LOCAL CONTROL REMOTES 1W

1870363	Situo 1 Variation io Pure II	129,70 €
---------	------------------------------	----------

1870366	Situo 1 Variation io Iron II	127,00 €
---------	------------------------------	----------

1870369	Situo 5 Variation A/M io Pure II	135,00 €
---------	----------------------------------	----------

1870373	Situo 5 Variation A/M io Iron II	164,90 €
---------	----------------------------------	----------

### io-homecontrol® - WALL LOCAL TRANSMITTERS 1W

1811003	Smoove 1 io Pure Shine	69,10 €
---------	------------------------	---------

1811005	Smoove 1 io Black Shine	78,00 €
---------	-------------------------	---------

1811007	Smoove 1 io Silver Shine	111,60 €
---------	--------------------------	----------

1811013	Smoove 1 A/M io Pure Shine	77,20 €
---------	----------------------------	---------

1811015	Smoove 1 A/M io Black Shine	111,60 €
---------	-----------------------------	----------

1811014	Smoove 1 A/M io Silver Shine	111,60 €
---------	------------------------------	----------

### io-homecontrol® - WEATHER SENSORS io

1818285	Sunis WireFree II io - new solar sensor	139,00 €
---------	---	----------

1816084	Eolis WireFree io - wind sensor for the facade	150,40 €
---------	--	----------

1870532	Soliris 230 V io - wind & solar sensor (without power supply cable) <b>NEW</b>	241,70 €
---------	--	----------

1816092	Eolis io - wind sensor (230V power supply - compatible with Onderis rain sensor) <b>NEW</b>	185,10 €
---------	---	----------

9016345	Czujnik deszczu Ondeis 230V	494,50 €
---------	-----------------------------	----------

### io-homecontrol® - OTHER CONTROL

1811131	EVB io - receiver for external blinds - with Hirschmann female plugs	219,60 €
---------	--	----------

1811132	EVB io - receiver for external blinds - with cables	325,00 €
---------	---	----------

1811583	Smoove Uno io Pure + Frame - radio receiver	271,40 €
---------	---	----------

## A-OK CONTROL SYSTEM



### RADIO TRANSMITTERS

AC133-01	1-channel wall transmitter <b>NEW</b>	20,30 €
----------	---------------------------------------	---------

AC133-02	2-channel wall transmitter <b>NEW</b>	23,80 €
----------	---------------------------------------	---------

AC133-05	5-channel wall transmitter <b>NEW</b>	26,80 €
----------	---------------------------------------	---------

AC152	Roller 6-channel remote control transmitter to control angles of louvers <b>NEW</b>	31,40 €
-------	---	---------

### WIND/LIGHT/RAIN SENSORS

AC302-02	Radio sun and wind sensor (230V power supply) <b>NEW</b>	102,20 €
----------	--	----------

### RADIO RECEIVERS

AC268-01	External blind control receiver with Hirschman plugs <b>NEW</b>	47,70 €
----------	---	---------

# ZF3000 EXTERNAL BLIND

## PRICE LIST OF CONTROL ELEMENTS

### PROLINE 2

e l e r o

#### WALL RADIO TRANSMITTERS

286501902	Monotec	59,60 €
286550001	QuinTec-868 5-channel transmitter **	103,20 €

#### RADIO TRANSMITTERS

282650002	Tempo Tel 2 10+ 1-channel remote with a timer	177,60 €
284350002	Monocom Slide 1-channel remote with a slider	91,40 €
284550002	Varicom Slide 6-channel remote with a slider	124,40 €

#### PROLINE 2 - WEATHER SENSOR

284600006	Aero-868 AC 230 V	333,00 €
284800006	Aero-868 Plus wind & sun sensor – solar powered	405,00 €

#### RADIO RECEIVERS

284000006	Revio-868 flush-mounted receiver ( with a possibility of a manual switch )	135,60 €
-----------	--	----------

### EXALUS HOME

#### CONTROL ELEMENTS

TR7	Control unit - smart house manager	349,90 €
-----	------------------------------------	----------

#### FLUSH RECEIVERS/ CONTROLLERS

VB-bidi	Radio flush-mounted external blind controller <b>NEW</b>	63,00 €
---------	--	---------

#### RADIO TRANSMITTERS

PXZF-bidi	1-channel remote <b>NEW</b>	53,40 €
NXZF-bidi	6-channel remote <b>NEW</b>	56,00 €
NX-BIDI-PRO	16-channel remote LCD with timer * <b>NEW</b>	103,80 €

#### WIND/LIGHT/RAIN SENSORS

WSZF-bidi	Wind/light/temperature sensor + power supply ZNP-02-12 <b>NEW</b>	102,80 €
-----------	---	----------

\* - Does not support time scenarios in VB-BIDI

\*\* - Product for special order

# MINIMUM DIMENSIONS OF EXTERNAL BLINDS

MOTOR	Minimum dimensions of External blinds							
	Guide F-PP-20 [mm]	BX External blinds			TP1000K ZF			SN5000
		Guide FBR 010/020/ F-PP-20 [mm]	Guide FBR 030/040 [mm]	Cord guide [mm]	Guide FBR 010 [mm]	Guide FBR 030 [mm]	Cord guide [mm]	Guide RSR-130 [mm]
J406 6/24 IO PROTECT	560	574	578	590	574	578	600	612
J406 6/24 WT	560	574	578	590	574	578	600	612
J406 6/24 WT PROTECT	560	574	578	590	574	578	600	612
J406 6/24 RTS	560	574	578	590	574	578	600	612
JA 06 SOFT	575	589	593	605	589	593	615	627
J410 10/24 WT	580	594	598	610	594	598	620	632
J410 10/24 WT PROTECT	580	594	598	610	594	598	620	632
J410 10/24 RTS	580	594	598	610	594	598	620	632
J410 10/24 IO PROTECT	580	594	598	610	594	598	620	632
JA 06 COMFORT - 868	590	604	608	620	604	608	630	642
JA 09 COMFORT - 868	600	614	618	630	614	618	640	652
J418 18/24 WT	600	614	618	630	614	618	640	652
J418 18/24 WT PROTECT	600	614	618	630	614	618	640	652
J418 18/24 RTS	600	614	618	630	614	618	640	652
J418 18/24 IO PROTECT	600	614	618	630	614	618	640	652
GJ5620	610	624	628	640	624	628	650	662
JA 09 SOFT	610	624	628	640	624	628	650	662
JA 20 DK	630	644	648	660	644	648	670	682
A-OK 6 Nm	580	594	598	610	594	598	620	632
A-OK 10 Nm	590	604	608	620	604	608	630	642
JA 09 NHK ZESTAW *	1001**	1 015	1 019	-	1 015	1 019	-	-
DOOYA VB55-6/22EL	630	644	648	660	644	648	670	682

\* - Crank outlet is exclusively on the right (looking from the inside)!

\*\* - Minimum width of the external blinds, version with cover sheets and with F-PP-20 guide rails :

- settings of the gear A, C minimum width - 1001 mm
- settings of the gear B minimum width - 750 mm

Minimum width of external blinds, version with cover sheets and with F-FBR guide rails :

- for F-FBR-030/40 settings of the gear A only minimum width - 1019mm
- for F-FBR-010/20 settings of the gear A only minimum width - 1015mm

Standard color selection of the PVC bottom cap for the F-FBR-010/020/030/040 guide/adaptor depending on the color of the paint/veneer..

PVC CAP COLOR	COLOR	VENEER COLOR
2 - BIAŁY	9 016	14
3 - SZARY	9006, 9007, 7035	94, 95, 96, 99
5 - BEŻOWY	VSR240	42, 55
8 - CIEMNY BRĄZ	-	17, 22, 34, 38, 66
9 - BRĄZOWY	VSR780,8014	30, 53, 61
20 - CZARNY	7021, 9005	11, 18
23 - ANTRACYT	7016, DB703	10, 12, 62, 63, 97
48 - ŻŁOTY DĄB	-	48
54 - WINCHESTER	-	54



## EXPLANATIONS TO THE ORDER FOR C80, Z90 PORTOS EXTERNAL BLINDS

The following rule of filling in orders shall be observed: first fill in the information on left side blinds and then in order from left to right when looking from inside the room.

1. Enter the number and date of placing the order, and the desired date of the order completion.
2. Please enter the delivery address for the blinds if established other than the company address.
3. Specify the color of the winding tape and ladder for the C80 or Z90 blind. Cord leading is a grey or black steel cord in a transparent PVC matrix. If the color is not specified, grey is assumed, except for slats with RAL9005 color where black is assumed.

No.	Dimensions of the blinds (including the box / cover / packages and guides)		Slats		BX box type				Leading				Safety plate				Drive type		Operation (viewed from the inside)	Notes: e.g. additional components, switches, remotes, type of the electric drive.																
	Quantity	Width (cm)	Height (cm)	Type (C80, Z90) (Fig. 1)	Color	Slat rotation (applies to C80)	Bottom lath	Box type (Fig. 3)	Box size (250, 300, 350)	Box color	Box insulation (type B or D)	Mosquito net	Mosquito Net Profiles	Color or Pleated	Brackets	Corner set	Corner type	Package with the main slat profile			Retruding connector (mm)	Type (Fig. 9)	Color	Guide handle type (FPP-20 FPP-40) only (Fig. 7)	Guide (FBR only) (Fig. 2)	Bottom end caps for FBR (Fig. 2)	Cord	Cord handle type (Fig. 8)	Type of safety plate (Fig. 4)	Side end cap of the safety plate (Fig. 6)	Plate thickness	Color	Crank length (other than standard)	Crank (standard 2/3 height)	Location of the passage axis	Motor
1	2	3	4	5	6	7	8	9	10	11	12	13	14	15	16	17	18	19	20	21	22	23	24	25	26	27	28	29	30	31	32	33	34	35	36	37

1. Enter the quantity of external blinds of the same type.
2. Enter the total width of the external blind according to the dimensioning method p. 5, 7, 9 and 11 in the catalogue.
3. Enter the total height of the external blind according to the dimensioning method p. 5, 7, 9 and 11 in the catalogue.
4. Specify the external blind type: C80 or Z90 according to Fig. 1 on the order form.
5. Choose the slat color according to the available color list (DB 703 - steel anthracite, 7016 - anthracite, 7021 - dark anthracite, 7035 - light grey, 9005 - black, 9006 - silver, 9007 - grey aluminium, 9016 - white, VSR 240 - beige, VSR 780 - olive, 8014 - brown).
6. Determine the slat rotation: 900 or 1800 (Standard is 900).
7. Choose the bottom lath color according to the available color list (DB 703 - steel anthracite, 7016 - anthracite, 7021 - dark anthracite, 7035 - light grey, 9005 - black, 9006 - silver, 9007 - grey aluminium, 9016 - white, VSR 240 - beige, VSR 780 - olive, 8014 - brown).
8. Enter the box type, A - flush-mounted installation, B - flush-mounted installation with a spacer, C - on the facade or D - on the facade with a spacer, as shown in Fig. 3.
9. Enter the box size 250, 300, 350.
10. Enter the color for the visible components of the box, it applies to bent sheet metal and the C and D type front profile. For A and B types, the top and front profiles are available in raw aluminium. The list of possible components to be varnished is available in the technical catalogue.
11. Mark X if the box is to have insulation attached to the back of the box in type B or D.
12. For the option with a rolled mosquito-net, enter X.
13. For the option with a pleated mosquito-net, enter X.
14. Choose the color of the pleated mosquito net profiles according to the available color list (DB 703 - steel anthracite, 7016 - anthracite, 7021 - dark anthracite, 7035 - light grey, 9005 - black, 9006 - silver, 9007 - grey aluminium, 9016 - white, VSR 240 - beige, VSR 780 - olive, 8014 - brown)
15. Please enter X if the brackets are to be installed. The bracket is from 150 cm inclusive, and each subsequent one every 100 - 120 cm.
16. Enter X if this item is to be formed a corner set. The following rule of filling in orders shall be observed: first fill in the information on left side blinds and then in order from left to right when looking from inside the room. If no clear specification is provided, it is assumed by default that the corner is convex. If a different type of corner is required, this must be clearly indicated in the remarks.
17. Specify the corner type (see the technical catalogue) - fill in as follows: N1 (version with cord guiding (a leading cord) installed with the main slat profile package), N2 (version with cord guiding (a leading cord) installed with the package of two side split slat profiles), N3 (corner guide), N4 (with FBR guides).
18. Enter X if this item is to be with the package with the main slat profile (protruding profile) - see Dimensioning (concerns only N1 type of the corner box).
19. In the case of the installation of the version with a corner guide, 'X' distance, by which the corner connector protrudes from the window frame, shall be additionally provided (concerns only N3 type of the corner box) - see Dimensioning.
20. Specify the type of external blind guides, enter PP-20 - single, PPD-40 - double, or full guides: 1 (F-FBR-010), 2 (F-FBR-020), 3 (F-FBR-030), 4 (F-FBR-040), 5 (F-FBR-070), 6 (F-FBR-080).
21. Choose the guide color according to the available color list (DB 703 - steel anthracite, 7016 - anthracite, 7021 - dark anthracite, 7035 - light grey, 9005 - black, 9006 - silver, 9007 - grey aluminium, 9016 - white, VSR 240 - beige, VSR 780 - olive, 8014 - brown).
22. Enter the selected type of the guide handle in accordance with Fig. 7 on the order form (Standard is A50-70 Type). TYPE A = F-UPP, TYPE B = F-UPT, TYPE C = F-UPL.
23. Mark X in the case of drilling the guides (only for the FBR guides). Note: If external blinds are divided by means of two FBR-030/040 divider guides, the heights of the mounting holes in such guides - when assembled together - may be non-aligned. In case of selection of this assembly solution, you are recommended to provide relevant information on the order/configuration form that no mounting holes should be drilled in the guides in given positions. The client shall then drill the mounting holes on their own. The same shall apply when Boxes are installed next to one another with the use of F-FBR-030/040 guides.
24. Mark X if you want to receive bottom end caps for guides inclined at an angle of 5 degrees, or A if you want to receive aluminium end caps for an additional charge (applies to FBR guides only).
25. Mark X in the case of using a steel cord leading.
26. Enter the selected type of the cord handle in accordance with Fig. 8 on the order form.
27. Enter the selected type of the safety plate in accordance with Fig. 4 on the order form. In the case of C80 blinds with cord leading, please enter the width of the safety plate in the "Notes" position.
28. Mark X in the case of using a side end cap for the safety plate (Fig. 6).
29. Determine the thickness of the safety plate: 1.5 mm or 2 mm.
30. Choose the color of the safety plate and side end caps according to the available color list (DB 703 - steel anthracite, 7016 - anthracite, 7021 - dark anthracite, 7035 - light grey, 9005 - black, 9006 - silver, 9007 - grey aluminium, 9016 - white, VSR 240 - beige, VSR 780 - olive, 8014 - brown). If side end caps are used for the safety plate, the color of the side end caps is the same as the color of the safety plate.
31. Enter the length of the crank other than the standard one. (Standard is 2/3 of the blind height).
32. Determine the angle of the crank guide entry 45° or 90°.
33. Specify the position of the crank guide entry (A: -17mm, B: +25mm, C: 0°). As standard, for aluminium guides the A position is assumed, while for the cord guide the C position is only available).
34. Electric drive. If an electric drive is used to operate an external blind, this fact should be marked with an X in the motor column. In case the motor is not specified, A-OK motor will be selected as standard.
35. Determine the cable entry - A at the back of the box, B - loose cable in the box, C - at the side of the box (Fig. 5). If the cable entry is not specified, the standard is B.
36. Side of the location of the crank / switch when viewed from the inside of the room. Failure to specify the control side results in a cable / crank lead to the Left side by default and, furthermore, in the case of the ZF3000-BX, in the cable output being changed to type B.
37. Suggestions regarding individual items (type of the electric drive, switches, remotes etc.) Additional notes or auxiliary figures can be placed under the table. All figures and sketches should be made with a view from the inside of the room.



## HOW TO FILL IN AN ORDER FOR PORTOS TOP MOUNTED ROLLER SHUTTERS - CC1000, TL1000, TP1000K WITH A MOSQUITO NET

1. Please provide the type of a window profile to select proper adjustment options - if you fail to specify the window profile, we will deliver a UNIVERSAL adapter. In case of the TP1000K system, please mark a relevant adjustable profile with an "X" sign. If none of the options is marked, the NPS-010 adjustable profile is deemed to be ordered.
2. Provide the number and date of order filing and the requested date of delivery.
3. If the delivery address is different than the company address, fill in such other address.
4. The order concerns the CC1000 shutters, when ordering the TL1000, TP1000K, TP1000K shutters with a MOSQUITO NET, please mark a relevant field in the order form with an "X" sign

1	2	3	4	5	6	7	8	9	10	11	12	13	14	15	16	17	18	19	20	21	22	23	24	25	26	27
Shutter size [cm] (with the box and guide rails)	width	width of the mosquito net only for TP1000K (division)	box size [mm]	box elevation (only for TP1000K-ZF)	box lowering (only for TP1000K-ZF)	box depth increase (only for TP1000K)	tapel outlet: A, B or C (marked on the shaft) (only for TP1000K-ZF) (Fig. 1.3)	types of guide rails (TP/CAU) (only for TP1000K-ZF) (Fig. 1.3)	cutting angle of PVC guide rails (from 0 to 45°) does not apply to TP1000K-ZF	location of the revision (inspection) A or B only for TP1000K (Fig. 2)	Box colour internal/external	colour of the revision (inspection) (only for TL1000/TP1000K)	colour of the guide rails	type of the shutter profile / slats	colour of the shutter profiles/slat as per the colour chart	colour of the bottom slat	MOSQUITO NET colour of the bottom slat	OPERATION (looking from the inside)	DRIVE manual crank with a winding (Cardan shaft) crank + lock + handles spring + motor	OPERATION (looking from the outside)	Colour of the plastering strip (TL1000, TP1000K)	Notes: e.g. colour of the winder, tape, additional elements: bolts, switches, remote controls, end caps				
	height	height of the mosquito net only for TP1000K (division)	box size [mm]	box elevation (only for TP1000K-ZF)	box lowering (only for TP1000K-ZF)	box depth increase (only for TP1000K)	tapel outlet: A, B or C (marked on the shaft) (only for TP1000K-ZF) (Fig. 1.3)	types of guide rails (TP/CAU) (only for TP1000K-ZF) (Fig. 1.3)	cutting angle of PVC guide rails (from 0 to 45°) does not apply to TP1000K-ZF	location of the revision (inspection) A or B only for TP1000K (Fig. 2)	Box colour internal/external	colour of the revision (inspection) (only for TL1000/TP1000K)	colour of the guide rails	type of the shutter profile / slats	colour of the shutter profiles/slat as per the colour chart	colour of the bottom slat	MOSQUITO NET colour of the bottom slat	OPERATION (looking from the inside)	DRIVE manual crank with a winding (Cardan shaft) crank + lock + handles spring + motor	OPERATION (looking from the outside)	Colour of the plastering strip (TL1000, TP1000K)	Notes: e.g. colour of the winder, tape, additional elements: bolts, switches, remote controls, end caps				

1. Width of the installed shutters (total width) with guide rails is specified in centimetres
2. Height of the installed shutters (total height with the box) is specified in centimetres
3. Specify the width and distribution of mosquito nets - applies to the TP1000K system with the shutter curtain profiles - one whole or divided mosquito nets. The dimensions shall be specified via measuring the distance from the external edge to the divider rail axis and/or between the axes of divider rails. Height of the mosquito net equals the height of the shutters.
4. Height of the box in millimetres, selected as per the table with winders. The box can be expanded for a surcharge of 5% of the net price of the shutters, if the box size is not specified, standard size as per the table with winders will be assumed. If the TP1000K-ZF system is ordered with the 280 box (actual dimension 281 mm), then the box is in fact the 250 box with the 31 mm expansion.
5. box elevation (expansion) (only the TP1000K-ZF shutters in boxes) - please mark with an "X" sign. Box elevation increases the height of the box by 3 cm.
6. box lowering (only the TP1000K-ZF shutters in boxes) - please mark with an "X" sign. Box lowering does not increase the height of the box.
7. specify the box depth increase - +31 mm or +62 mm (concerns only TP1000K)
8. tapel outlet, enter A, B or C (concerns only TP1000K see Fig. 1, table of orders) and Cardan shaft outlet enter A, B (concerns only TP1000K see Fig. 3). In the TP1000K-ZF system, the only available Cardan shaft outlet option is B
9. specify the shutter curtain profile guide rails type - enter SIN (single), DOU (double) or SDB (single+double). In the TP1000K-ZF system, aluminium guide rails can be used. If you want aluminium guide rails, then fill in as follows ALU-SIN (aluminium, single), ALU-DOU (aluminium, double) or ALU-SDB (aluminium single+double)
10. enter the angle of the PVC guide rail cutting from 0 - 45°
11. manner of the revision (inspection) cover opening, enter A or B (concerns only TP1000K see Fig. 2 order table)
12. colours (boxes): int - internal, ext - external,  
Available colours: white - 02, lining (colours of lining - cover), CC1000 - if a white box 02 is ordered and lined guide rails, the external side of the shutters will be smooth and white. Assuming the colours as above, and additionally with the option of the plastering strip, the external side of the blinds will be grooved, and will be provided at the bottom with a 1,5 cm strip of the same colour as the guide rails (135 mm box will make an exception - the external side will be smooth and provided at the bottom with a 1,5 cm strip with lining).
13. colour of the revision (inspection) cover (concerns only TL1000). Available colours: white - 02, lining - please refer to the cover
14. colours (guide rails): white - 02, lined (colours of lining - please refer to the cover)
15. enter the selected profile: PA - 39 (aluminium profile) PA - 45 (aluminium profile) PA - 52 (aluminium profile) PA - 52 are only available in the TP1000K system - see tables with winders)
16. colour designation of PA - 39, PA - 45 profile (as per the colour chart on the last page, cover) (if the profile is to be free of any perforations, instead of the "X" sign, enter 1, e.g. 02 - white perforated, 102 - white, with no perforations)

### Note! - profile with no perforations is typically used in case of coil spring lifting mechanism

17. colour of the bottom slat:  
- 01 - silver, 02 - white, 03 - grey, 05 - beige, 08 - dark brown, 09 - brown, 16 - ivory, 23 - anthracite grey (standard, with no additional fees),  
- other varnish colours similar to the colour of the shutter curtain profile shall be specified using the profile colour symbol (apart from colours 22, 30, 48, 54) also non-standard colours as per RAL colour table,  
- bottom slat can also be lined (see the list of lining colours - cover),  
18. net colours (concerns the mosquito net) - 03 - grey and 20 - black,  
19. colour of the motor drive (mark with an "X" sign in the column of the motor drive selected),  
20. selection of the motor drive (concerns the mosquito net) - 01 - silver, 02 - white, 03 - grey, 05 - beige, 08 - dark brown, 09 - brown, 16 - ivory, 23 - anthracite grey (standard, with no additional fees)  
21. box with the tape crank gear - available in white and brown, if the box colour is not specified, then white will be assumed as a standard, with a grey tape. In case of shutters with a box with double-sided lining, and in case of the TL1000 shutters with lined revision (inspection) cover, the tape crank gear and the tape are brown as a standard,  
22. A Cardan gear mechanism 90 0 - crank extension - see Fig. 3,  
23. coil spring lifting mechanism and espagnolet lock in the bottom slat,  
24. electric drive (if the motor is not specified - cable PORTOS motor will be assumed as a standard, in the TP1000K-ZF system - ELERO SOFT motor),  
25. side of the tape winder location (box, crank and switch) looking from the inside,  
26. in the TL1000 and TP1000K systems, the side where the plastering strip is to be fixed shall be selected - ext./int. Please, mark the colour: 02 - white, 08 - dark brown, 09 - brown, 23 - anthracite grey. In case of the TP1000K-ZF system, the following colours are available: DB 703 - metallic grey, 7016 - anthracite grey, 7021 - dark grey, 7035 - light grey, 9005 - black, 9006 - white aluminium, 9007 - grey aluminium, 9016 - white, VSR 240 - beige, VSR 780 - olive. In the CC1000 system, the plastering strip is installed only on the external side. If the client has selected the plastering strip, the box will come with frontal reinforcement. In the TP1000K system, frontal box reinforcement is installed only on the external side.
27. Notes to respective items, e.g. colour of the winder and the tape, additional fit-out, e.g. bolts, etc. Drawings of sets and sketches (all from the inside). Notes can be also made under the table.



# AN ORDER FOR PR6000 PERGOLAS



**PR6000 HT**



Fig. 1

no.                      date:                      delivery date:

seal of the Ordering Party

address of delivery

(if other than the address of the Ordering Party)

**PR6000 LITE**



Available in dimensions:

- Width / Outreach [cm] \*
- 300 x 300
- 300 x 352.4
- 300 x 404.8
- 350 x 300
- 350 x 352.4
- 350 x 404.8

\* - given dimensions are fixed sizes of pergola PR6000 LITE. Maximum height up to 260 cm.



Fig. 2



Fig. 3



Fig. 4

No.	Quantity	Total dimensions of the pergola		Type of assembly [Fig.1] - only applies to PR6000 HT	Colour of the gutter	Elevation - only applies to PR6000 HT	Colour of columns	Colour of roof slats	Masking profile - only applies to PR6000 HT	LED lighting profile	Distribution of drainage system openings in the gutter [Fig. 2]	Drainage system openings in the columns [Fig. 3]	Type of a bottom connector of the column [Fig.4] - only applies to PR6000 HT	Motor operation [Fig. 2] - only applies to PR6000 HT	Notes:		
		Width [cm]	Outreach [cm]													Height [cm]	
1																	
2																	
3																	
4																	
5																	
6																	
7																	
8																	
9																	
10																	

NOTES, SKETCHES (VIEW FROM THE INSIDE)

Before filling in the form, please read the instructions.

**NOTE:** Changing printed contents of the form may result in errors in order fulfillment. Complaints resulting therefrom will be dismissed. I represent that I provide - to you - personal data of a natural person for the purpose of order fulfillment on the basis of my consent for processing of personal data disclosed in accordance with the Regulation of the EU Parliament and Council (EU) 2016/679 of 27 April 2016.

By filing this order form, you accept the General terms and conditions of sales and deliveries of PORTOS TR7 included in the Roller Shutter/External Blinds Price list or on the website [https://portosrolety.pl/download/ogolnewarunki\\_pl.pdf](https://portosrolety.pl/download/ogolnewarunki_pl.pdf)

## HOW TO FILL IN AN ORDER FOR PR6000 PERGOLAS

1. Provide number and date of order filing and the requested date of order completion.
2. If the delivery address is different than the company address, fill in such other address.

No.	Quantity	Total dimensions of the pergola			Type of assembly (Fig.1) - only applies to PR6000 HT	Colour of the gutter	Elevation - only applies to PR6000 HT	Colour of columns	Colour of roof slats	Masking profile - only applies to PR6000 HT	LED lighting profile	Distribution of drainage system openings in the gutter (Fig. 2)	Drainage system openings in the columns (Fig. 3)	Type of a bottom connector of the column (Fig.4) - only applies to PR6000 HT	Motor operation (Fig. 2) - only applies to PR6000 HT	Notes:
		Width (cm)	Outreach (cm)	Height (cm)												
1		2	3	4		6	7	8	9	10	11	12	13	14	15	16

1. Fill in the quantity of pergolas.
2. Width of the completely assembled pergola (total width) in centimetres, in compliance with the measuring method on page 11 of the catalogue. For the PR6000 LITE pergola, select one of the available dimensions.
3. Outreach of the completely assembled pergola (total outreach) in centimetres, in compliance with the measuring method on page 11 of the catalogue. For the PR6000 LITE pergola, select one of the available dimensions.
4. Height of the completely assembled pergola (total height with the side profile (main gutter) in centimetres, in compliance with the measuring method on page 11 of the catalogue.
5. Specify type of the assembly: WS - standalone, PR-WY - wall-mounted, with outreach facing the wall, PR-SZ - wall-mounted, assembled alongside its width (Fig. 1). Applies only to the PR6000 HT.
6. Colour of the pergola gutter: available colours - white RAL9016, anthracite grey - RAL7016, black grey - RAL7021.
7. Mark with an 'X' sign if you want your pergola to have a height extending profile (the profile will increase the height of the pergola by 12 cm and will come in the main gutter colour). Applies only to the PR6000 HT.
8. Colour of the pergola columns: available colours - white RAL9016, anthracite grey - RAL7016, black grey - RAL7021.
9. Colour of the pergola roof slats: available colours - white RAL9016, anthracite grey - RAL7016, black grey - RAL7021.
10. Mark with an 'X' sign if you want your pergola main gutter to have a masking profile (in the main gutter colour). Applies only to the PR6000 HT.
11. Mark with an 'X' sign if you want your pergola main gutter to have a LED lighting profile (in the main gutter colour).
12. Indicate where the drainage system openings are to be made in the gutter. It is recommended to locate such openings opposite the motor.  
Indicate two locations as shown in Figure 3 - A, B, C or D.
13. Mark with an 'X' sign if you want rainwater drainage system openings to be made in the columns (Fig.3).
14. Specify type of a bottom connector of the column A - hidden, B - with a gantry plate (Fig. 4). Applies only to the PR6000 HT.
15. Mark the side where the motor control panel is to be installed in compliance with Figure 2 - A, B, C or D. The side of the panel installation predetermines the direction of slat opening. Applies only to the PR6000 HT. In the PR6000 LITE pergola, the motor is mounted in the middle of the gutter.
16. Additional notes to respective items. Drawings and sketches (all from the inside).



# ORDER FOR PLEATED MOSQUITO NETS

no. \_\_\_\_\_ date: \_\_\_\_\_

delivery date: \_\_\_\_\_

seal of the Ordering Party

address of delivery  
(if other than the address of the Ordering Party)

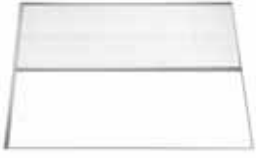

**Pleated mosquito net  
Single**

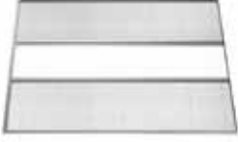

**Pleated mosquito net  
Double**

No.	Quantity	Mosquito net size		Mosquito net type (PJ - single, PD - double)	Colour of the profile	Type of installation			Notes:
		Width (cm)	Height (cm)			In guides	Independent	Independent in the niche	
1									
2									
3									
4									
5									
6									
7									
8									
9									
10									

NOTES, SKETCHES (VIEW FROM THE INSIDE)

Before filling in the form, please read the instructions.

**NOTE:** Changing printed contents of the form may result in errors in order fulfillment. Complaints resulting therefrom will be dismissed. I represent that I provide - to you - personal data of a natural person for the purpose of order fulfillment on the basis on my consent for processing of personal data disclosed in accordance with the Regulation of the EU Parliament and Council (EU) 2016/679 of 27 April 2016.

By filing this order form, you accept the General terms and conditions of sales and deliveries of PORTOS TR7 included in the Roller Shutter/External Blinds Price list or on the website [https://portosrolety.pl/download/ogolnewarunki\\_pl.pdf](https://portosrolety.pl/download/ogolnewarunki_pl.pdf)

## HOW TO FILL IN AN ORDER FOR PLEATED MOSQUITO NETS

1. Enter number and date of placing the order and the desired date of the order completion.
2. Please, enter the delivery address, if different than the company address.

No.	Quantity	Mosquito net size		Mosquito net type (POJ - single, PD - double)	Colour of the profile	Type of installation			Notes:
		Width (cm)	Height (cm)			In guides	Independent	Independent in the niche	
1		2	3	4	5			6	7

1. Enter the right quantity of pleated mosquito nets.
2. Enter the width of the clear opening for the mosquito net frame.
3. Enter the height of the clear opening for the mosquito net frame.
4. Enter the mosquito net type: POJ - single, PD - double.
5. Enter the colour of the mosquito net profile. 01 - silver, 02 - white, 03 - grey, 05 - beige, 08 - dark brown, 09 - brown, 16 - ivory, 23 - anthracite grey.
6. Mark the selected type of the mosquito net with an "X".
7. Notes concerning all items.

# EXAMPLE OF FILLING IN ORDER FORM

An exemplary sketch of a set of two ZF3000 external blinds in one box with completed order forms.

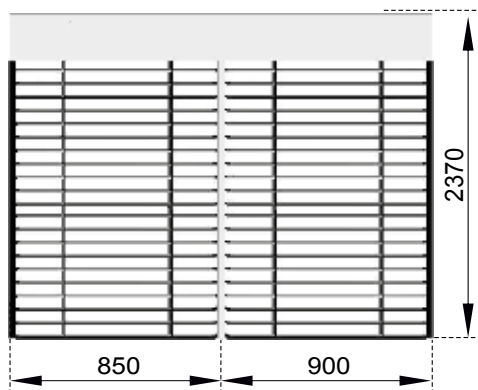

- Define the type of the inside guide and side guides. The presented example shows a double inside guide (PPD-40) and side guides (FBR-030).
- In the Notes column, check the items included in the set.
- A set: double-sided external blinds (view from the inside). When ordering double-sided external blinds, on the order form, first fill in the information on the left side blinds and then those on the right side looking from the inside of the premises. Both sides of external blinds are 237 cm high.
- Select the type of the inside guide (PPD-40) holder. Our example shows B type holder (71-105) filled in the form. This type of holder is also selected if the holder type has failed to be provided in the order form.

**PORTOS** ORDER FOR EXTERNAL BLINDS

No. of stamp of the Ordering Party: \_\_\_\_\_ delivery date: \_\_\_\_\_  
 delivery address (if different from the Ordering Party): \_\_\_\_\_

Fig. 1 Fig. 2 Fig. 3 Fig. 4 Fig. 5 Fig. 6 Fig. 7 Fig. 8

No.	Quantity	Dimensions of the blinds (including the box / cover / package and guides)		Color	Slat rotation (applies to C80)	Bot- tom lath	BX box type				Mos- quito net	Bran- dets	Guide				Bottom end caps for FBR	Cord	Cord handle type (Fig. 7)	Type of safety plate (Fig. 3)	Safety plate		Crank length (other than stan- dard)	45/90	Location of the passage axis	Motor	Cable entry (only for BX boxes) (Fig. 5)	Operation (viewed from the inside)		Notes: to addi- tional parts, in- stru- ctions, etc. type of the electric drive.						
		Width (cm)	Height (cm)				Box size (Fig. 2)	Box size (250, 300, 350)	Box color	Box in addition (for type B or D)			PPD-40, PPD-40, PPD-40, PPD-40	Guide handle type (Fig. 6)	Guide drilling (FBR only)	Plate thickness					1,5 mm	2 mm						Color	L		R					
1	1	85	237	C80	7016	X	7016	A	300	7016		X	FBR-030/PPD-40	7016	B 71-105	X	X												X	A			SET			
2	1	90	237	C80	7016	X	7016	A	300	7016		X	PPD-40/FBR-030	7016		X	X											X	A			SET				
3																																				
4																																				
5																																				
6																																				
7																																				
8																																				
9																																				

NOTES, SKETCHES (VIEW FROM THE INSIDE)

Please read the explanations before completing the form.  
**NOTE:** Individual changes in the content of the order form can lead to the incorrect completion of the order. Complaints of this type shall not be considered.  
 I hereby declare that I transfer personal data of a natural person to you for the purpose of the contract execution under the consent for processing of personal data disclosed in compliance with Regulation (EU) 2016/679 of the European Parliament and of the Council of 27 April 2016.

## Standards and tolerance ranges

Portos external blinds are manufactured in accordance with the current European and national technological standards. All elements of the system are within the tolerances defined by internal technological standards. The maximum differences in the dimensions of the external blinds are 5 mm. Aligning may be visible on the surface of FBR guide rails and adapters.

## Operation of the external blind sets

A natural phenomenon occurring during the operation of an external blind set are slight differences in the work between individual packages. Differences, such as: non-collinear position or non-synchronized movement of the slats may occur in the inter-connected blinds. These differences may intensify in wide and tall constructions. To prevent this from happening, leave a 5 mm expansion gap between the individual sheets during the installation of the entire system.

## Slat position

While rolling external blinds, the cords may wind up between individual slats. As a consequence, the blind package may become unevenly rolled and the position of the slats may be non-collinear. This effect will intensify with increasing blind height. In such a case, just remove the cords gently from the space between the slats. Due to the natural behavior of the textiles, a one-sided deviation of the bottom lath in relation to the horizontal axis is allowed. In case of slats C80, the heights of packages are adapted to 180-degree rotation. However, in case of 90-degree rotation, the package may roll up in a non-linear fashion, therefore, the total height may be greater and, as a result, it may stick out of the sheet metal or box.

## Motor configuration

At the production stage, the motor installed inside the system was pre-configured and programmed. After installing the entire package, the motor parameters and end positions should be adjusted to the current operating conditions. The use of a mounting cable will be necessary to set them.

## Operation and maintenance

When using the external blind system, follow the manufacturer's recommendations and instructions. During proper use of external blinds, there should be no deformation of structural elements. It is recommended to use external blinds in the temperature range from -25°C to +45°C.

### Note - The blinds should not be used when the bottom lath is iced.

Within the blind operating range, there should be no objects or persons that may disturb its operation.

When the blind is fully open, the bottom lath should be in the side guides.

Before using the external blinds, remove any dirt from the seals installed in the side guides.

An electro-mechanical drive or a manual drive (crank mechanism) can be used to open and close the external blinds.

### Note - The continuous operation of the blind electric motor should not be longer than 4 minutes.

In compliance with these operating instructions, inspection and maintenance works must be carried out at least every 3 months. Basic maintenance operations consisting in removing sand and other impurities from the curtain and the inside of the guides as well as visual inspection of the general condition of the blind, completeness control and operational effectiveness of all structural elements should be carried out on an ongoing basis.

### Note - Basic maintenance operations can be performed by the user with no special entitlements.

When conducting basic maintenance operations, the following rules must be observed:

1. Disconnect the power supply before starting the maintenance of the external blind.
2. Do not use sharp or rough tools to clean the blind.
3. Do not use any viscous preservatives, such as spray grease.
4. External blinds shall be cleaned with lukewarm water and mild neutral pH detergents, preferably at the temperatures not lower than +10°C. The use of pressure washers or detergents containing ammonia, chlorine and bleach of any kind is prohibited. Avoid detergents containing solvents or diluents, such as petrol, alcohol, acetone. It is also prohibited to use such detergents or solvents in areas near the external blinds. Non-observance of the aforementioned rules highly increases the risk of corrosion and damage of the slat coating.

### NOTE - The use of strong detergents and corrosive substances may damage or discolor the finish coating.

The manufacturer is not responsible for any damage caused by: improper use, negative effects of weather conditions, intentional damage and natural wear of the products. Wear and tear of the paint coating of the shutter curtain, in the form of scratches around areas in direct contact with components of external blinds, shall be deemed as usual wear and tear.

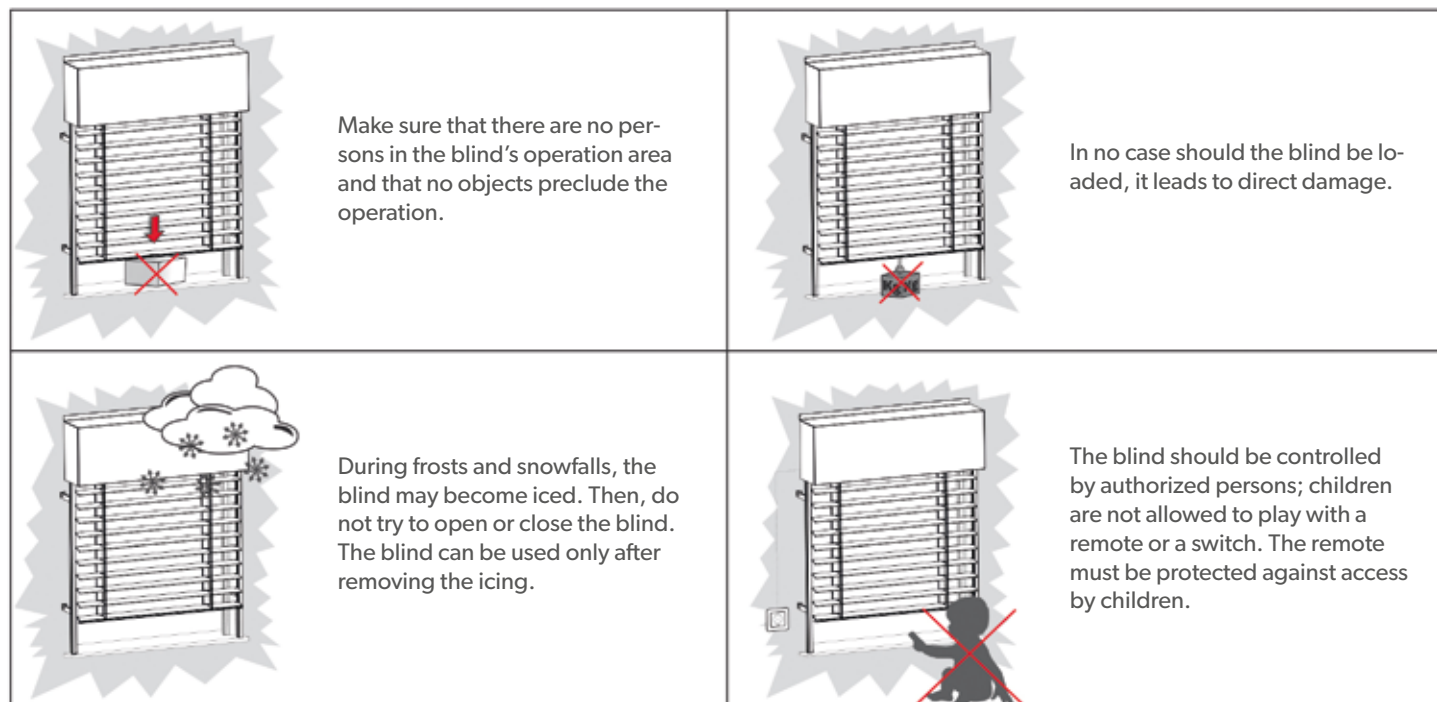

# GENERAL CONDITIONS OF SALE AND DELIVERY FOR PRODUCTS OF PORTOS TR7

I. I. The terms used in these Regulations have the following meanings:

**Seller / PORTOS** - PORTOS TR 7 Spółka z ograniczoną odpowiedzialnością based in Kalisz, address: ul. Złota 71, 62-800 Kalisz, entered into the Register of Entrepreneurs of the National Court Register by the District Court Poznań - Nowe Miasto and Wilda in Poznań under KRS number 0001055147, NIP 6180018618, REGON 250410218;

**Buyer** - a legal person or a natural person conducting business activity and ordering goods included in the Seller's commercial offer directly related to their business and professional activity, for further distribution;

**Parties** - the Seller and the Buyer jointly;

**Product / Goods** - products included in the Seller's commercial offer.

## II. PRICE

1. The Prices are net prices (they do not include VAT). The Buyer reduces the Prices indicated in the price list by the individual discount granted to him.
2. The given Prices are unit prices of goods with specified dimensions, expressed in units, running meters, pairs or sets.
3. The Price includes the cost of transporting the Products to the Buyer's registered office/ sales point, unless otherwise agreed by the Parties.
4. PORTOS may unilaterally change the price in the case of ordering at least 50 roller shutters or at least 20 roller shutters of the same size.

## III. PAYMENT AND DELIVERY

1. The place and date of delivery shall be specified by the Buyer in the order content.
2. The time of order completion in colors and with equipment specified as standard lasts 21 working days from the date of receipt of a written order by the Seller. Earlier or later date of delivery of standard products and the date of completion of non-standard products shall be agreed individually by the Parties. In special cases beyond the control of the Seller, the order completion date may be extended.
3. Orders should be submitted in writing, by fax or e-mail, exclusively using the original PORTOS order forms or via the Product Configurator made available by PORTOS.
4. Placing an order is tantamount to accepting it for implementation, however, the Seller reserves the right to suspend the order execution in the event of exceeding the value of the trade credit granted or delay in payment of any receivables until the due amounts or prepayments are settled.
5. The cancellation or change of the order by the Buyer may be accepted by the Seller without any consequences only if the order has not been made (manufactured) yet. If the Buyer cancels an order already made, he is obliged to pay the full price due.
6. At the request of the Buyer, the Seller may repurchase the previously sold automation components, provided that the returned goods do not show traces of use, are not damaged, are packed in original packaging and no more than 3 months have passed from the date of release.
7. Detailed terms of cooperation, in particular discounts and payment terms, may be specified in the "Terms of cooperation" delivered in writing to the Buyer.
8. The "Terms of cooperation" may be changed only if delivered to the Buyer in writing.
9. The day of making the payment is considered to be the date on which the Seller received cash, and in the case of a transfer, the date of crediting the Seller's account.
10. The Seller may change the terms and conditions of cooperation with immediate effect without notifying the Buyer, if the Buyer:
  - a) makes late payments for the delivered goods,
  - b) grossly violates the terms of cooperation,
  - c) has filed an unfounded complaint at least twice.
11. The Buyer undertakes to collect the ordered goods at the agreed time and carry out unloading at the place of delivery.
12. Risks of damage or loss of Goods shall pass to the Buyer upon starting the unloading.
13. The Buyer may collect the Goods with his own transport during the working hours of the Seller's warehouses and after prior appointment. In the event of collecting by a person other than the owner of the company or a person authorized to represent the Buyer in accordance with the entry in the relevant register of entrepreneurs, a written authorization for collection issued by a person authorized to represent the Buyer is required.
14. At the request of the Buyer, the Seller may send the Goods using forwarding or courier services. In this case, the shipping costs are borne by the Buyer, and upon the release of the Goods, the risk of its loss or damage passes to the Buyer.
15. Handing over of goods to the Buyer is always carried out on the basis of a delivery note (WZ). Signing the document by both Parties without any objections means that the Goods have been handed over in quantity included in the delivery note and have no apparent defects.
16. If the Buyer fails to collect the goods on the previously agreed and confirmed date, the Buyer shall pay to the Seller a contractual penalty in the amount of 1% (one percent) of the gross value of the uncollected order for each day of storing the goods uncollected by the Buyer. Re-delivery to the Buyer's registered office/ sales point shall be made upon payment of the contractual penalty referred to in the preceding sentence and payment of the entire price for the uncollected delivery. The Seller may demand from the Buyer a complementary compensation if the contractual penalty does not cover the damage suffered by the Seller.
17. After one month has passed from the day on which the Buyer was obliged to collect the goods, the Seller may withdraw from the contract within a further period of two months, without prejudice to the Buyer's obligation to pay the contractual penalty for failure to collect the goods on time.

## IV. COMPLAINTS OF APPARENT AND QUANTITATIVE DEFECTS

1. A complaint procedure is processed as defined in the Product Warranty Certificate. In case of any discrepancies between these Sales Terms and Conditions and the content of the Product Warranty Certificate, the provisions of Warranty Certificate shall prevail.
2. It is the duty of the Buyer to check the quantity of delivered Products at the time of delivery. Any discrepancies shall be immediately reported to the driver or the warehouse worker and recorded in the Stock Issue Confirmation or otherwise the Buyer shall lose its right to raise any claims thereunder.
3. Any missing quantities of Goods shall be immediately delivered by the Seller and the Buyer shall be obliged to pay for the actually delivered goods within the agreed deadline.
4. Apparent defects such as: mechanical damage, deep scratches, cracks and broken items shall be reported at the time of delivery and recorded in the Stock Issue Confirmation or otherwise the Buyer shall lose its right to raise any claims thereunder. Complaints concerning scratched, dented, bent or damaged elements shall not be considered if the roller shutter has been installed.
5. Any Product with apparent defects, which has been returned to the Seller, shall be immediately repaired or replaced by the Seller.
6. The Buyer shall be obliged to pay for the delivered Goods in the part that is not complained about.
7. The Buyer acknowledges that the Seller has disclaimed its liability under the warranty for the Products sold, moreover, the Buyer fully understands the effects of such a disclaimer, accepts it and consents thereto before placing the order.
8. Minor defects, that are invisible after the installation, such as: scratches on the aluminum box adjacent to the wall, shall not be subject to complaints and are excluded from the warranty.
9. Orders placed in a form other than an original order form of the Seller shall not be subject to complaints.

## V. WARRANTY

1. The Seller hereby grants the Warranty for the purchased Products on terms and conditions specified in the Product Warranty Certificate. In case of any discrepancies between these Sales Terms and Conditions and the content of the Product Warranty Certificate, the provisions of Warranty Certificate shall prevail.
2. Any defects that cannot be identified at the time of delivery shall be reported by the Buyer in writing, forthwith after finding such defects, but not later than 14 days after the delivery of goods or otherwise the Buyer shall lose its rights under the warranty.
3. The Buyer's rights under the Warranty arise once the delivered Products are fully paid for.
4. The Guarantee excludes any products customized to the needs of the Buyer or tailor made pursuant to the Client's order, which are not included in the product offering range of the Seller.
5. The Warranty excludes any effects of improper installation (connection) of the purchased Products, their improper use, regular wear and tear and the cases specified in the Warranty Certificate.
6. The Seller shall repair the Product or replace it with a Product free of defects within 30 days as of the date of filing the complaint, with the reservation that the time needed for the removal of more complex defects may be extended. The time for the removal of defects may also be extended should any subassemblies require to be replaced and the Manufacturer does not have them or should any adverse weather conditions occur in the place where the defect is to be removed, which prevent the

implementation of any technological process necessary for the defect removal.

7. Differences in shades of components of the product of the same colours, in particular woodgrain colours, as well as differences caused by structural colour patterns. These discrepancies are dependent on the semi-finished products delivered by manufacturers at different intervals.
8. For wood-like coloured curtains some tonal difference, such as subtle streaks and stripes of lighter and darker tones might occur. This is a result of characteristics of the production process and imitation of wood structure. Differences of that type are not the ground for complaint.
9. Because of natural external factors, such as temperature and humidity and its own weight, the roller shutter curtain might distort and result in nonlinear layering. Prolonged lowered position of the curtain might result in distortion of brush seals located in the guide, which causes nonlinear layering. Distortion of this type does not influence technical characteristics and durability of the curtain and is not the ground for complaint.
10. The Buyer shall lose its rights under the Warranty if the Product has been damaged as a result of the Buyer's failure to observe recommendations included in the assembly manuals and in technical specifications for roller shutters, gates, roller security shutters and electrical equipment.
11. Services under the warranty are provided only for PORTOS products installed on the territory of Poland. In case of PORTOS products installed outside of the territory of Poland, the warranty services consist in sending relevant self-repair kits and it is the Buyer who performs all the necessary repairs at its own cost and risk.
12. In case of built-in elements of roller shutters or gates, such as guides or access doors, the Buyer, at its own expense, shall be obliged to provide the Seller's service technician with free access to the roller shutter or gate so that they could be repaired. In case of roller shutters installed at any level higher than the ground floor, the Buyer shall provide a scissor lift or scaffolding.
13. Should the warranty service technician be called without justified reasons, the Buyer shall bear the travel costs to the installation place of the product complained about and the costs of repair.

## VI. DOCUMENTS REQUIRED FOR COOPERATION

1. In order to start commercial cooperation, the Buyer is obliged to submit the following documents to PORTOS:
  - Certificate of entry in the register of business activity or excerpt from the register of entrepreneurs of the National Court Register or other register of entrepreneurs kept by the state in which the Buyer has its registered office;
  - Certificate of assignment of the REGON number;
  - Decision on assigning a tax identification number (NIP);
  - Declaration of consent for issuing invoices without a signature (original) and a list of persons authorized to receive and sign VAT invoices - signed by a person authorized to represent the Buyer or a person authorized by him in writing.

## VII. TERMS AND CONDITIONS OF THE PRODUCT COLLECTION FROM THE BUYER

1. Terms and conditions of the Product collection by the Seller, which are stipulated herein, shall apply to:
  - a) paid modifications of the Product, made in particular according to the Buyer's specifications, customised according to the Buyer's order or if the warranty does not apply, including after the expiry of the warranty;
  - b) free of charge modifications of the Product, made in particular within the warranty claim or due to a justified complaint;
  - c) any buy-back of the Product by PORTOS, on terms and conditions of these General Conditions of Sale and with the reservation of Goods specified in III (6) hereof.
2. Paid and free of charge modifications are in particular repairs or replacements of the Product, its parts or components. Costs of paid modifications may be waived or appropriately shared between the Seller and the Buyer, following a prior agreement between the Parties.
3. The provisions hereof and the Warranty Certificate that pertain to differences in colour, shades and shade differences within one and the same colour shall respectively apply to the replacement of the Product, its parts or components.
4. The Product is collected on dates indicated by the Seller, using the Seller's means of transport. The Parties agree that the Product may be personally delivered by the Buyer or sent via any carrier or courier mail service, with the reservation that all costs and risks related to the damage or loss of the Product during the delivery to the registered address of the Seller shall be borne by the Buyer.
5. In the case of paid modifications, the Seller shall charge an additional fee of PLN 100 net for the transport service each time. This fee shall be charged separately for the collection of the Product and for its re-delivery to the registered address or point of sale of the Buyer, if the Seller's transport is individually organised exclusively for the Buyer's Products.
6. The Buyer undertakes to hand over the Product to the Seller against a hand-over and acceptance certificate, which shall include:
  - a) designation of the type of the Product;
  - b) quantity;
  - c) description of the technical condition and
  - d) specification of any found defects (if any)- or otherwise, the Seller shall refuse to collect the Product.
7. If the Product is collected due to a warranty claim, a justified complaint, or a buy-back, the Buyer - in addition to the obligation specified in the preceding section - shall be required to prior submit a written notice to the Complaint Department.
8. Notwithstanding the foregoing section, the Seller shall collect the Product from the Buyer without any prior notice submitted to the Complaint Department if the Buyer appends the complaint form to the Product, with the reservation that this shall exclusively concern the Product collection within the framework of the warranty claim or a justified complaint.
9. The complaint shall be submitted on the complaint form available for download from [portosrolety.pl](http://portosrolety.pl)

## VIII. FORCE MAJEURE

1. The Seller shall not be liable for any failure to perform or improper performance of its obligations, in particular for changes in delivery dates, prices or delivery conditions, provided that such failure or improper performance results from force majeure.
2. Force majeure shall be understood by the Parties as events of a global nature, in particular raw material crises, armed conflicts, sanctions, as well as other unforeseeable events disrupting the Seller's production and logistics processes.
3. The Seller shall promptly inform the Buyer of any changes resulting from force majeure.
4. The Seller shall be entitled to withdraw from the contract in whole or in part within 3 months from the occurrence of the circumstances referred to above.

## IX. OTHER PROVISIONS

1. At the Buyer's request, the Seller may organize a training on the installation, service and repairs of the offered products.
2. The Seller undertakes to provide the Buyer with a catalog of finished products and advertising brochures free of charge.
3. At the request of the Buyer, the Seller may make a roller shutter for advertising and exhibition purposes, including a partial refund of the exhibition in the form of an individually agreed discount.
4. The Seller reserves the right to make technical and design changes in the presented catalog offer without prior notification to the Buyer.
5. The Seller reserves the right to update prices in the event of a significant increase in exchange rates (EUR, USD) or metal prices (LME). The Seller shall promptly inform the Buyer of any price updates.
6. These General Terms of Sale and Delivery are the only contractual regulation binding on the parties for the sale of goods.
7. The Buyer accepts the above terms of sale and delivery by placing the relevant signature at the time of placing the order or - in the case of placing an order via the Product Configurator made available by PORTOS - by clicking the "Order" button.
8. In matters not covered by the above provisions, the relevant provisions of the Civil Code shall apply.
9. All disputes arising from the implementation of the above provisions shall be settled by the common court competent for the Seller's registered office.
10. In the absence of consent or confirmation thereof for the receipt of commercial information, any content necessary for the establishment, performance, amendment or termination of the relationship between the Seller and the Buyer shall be communicated via e-mail.
11. All photos and drawings contained in the catalog are for reference only.
12. Detailed installation instructions for roller shutters and Products are included on the website [www.portosrolety.pl](http://www.portosrolety.pl).

.....  
/place, date/

.....  
/stamp of the Complaining Party/

# COMPLAINT

I am filing a complaint for external blinds at PORTOS – according to the Invoice

No. .... of ....., delivery note No. .... item .....

The complaint refers to: .....

.....  
.....  
.....  
.....  
.....  
.....  
.....  
.....  
.....  
.....

Therefore, I am asking for: .....

.....  
.....  
.....  
.....  
.....  
.....

Contact details of a person with SEP rights to connect drives\* .....

.....  
.....  
.....  
.....

I understand that:

- In the event of an unjustified call for warranty service, i.e. in which the service technician did not find an error on the part of the PORTOS company, the Complaining Party shall be charged with travel costs and possible repair;
- In the event of a call and arrival of a service technician from the PORTOS company, a representative of the Complaining Party must be at the place of the complaint, for determination of the fault, defect and the manner of its removal.

I hereby declare that I transfer personal data of a natural person to you for the purpose of the complaint handling process under the consent for processing of personal data disclosed in compliance with Regulation (EU) 2016/679 of the European Parliament and of the Council of 27 April 2016.

\* - refers to complaints about drives

.....  
/signature of the person making the complaint/

# COLOURS OF VENEER ZF3000, TP1000K-ZF

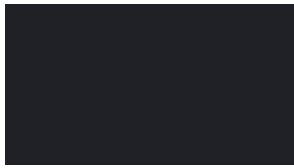

10 - Plain anthracite  
(nr KDB74-F7)



11 - Palisander\*  
(nr H-426-5010)



12 - Anthracite  
(nr KDB74-Z8)



14 - Creamy white\*  
(nr H-456-5015)



17 - Chocolate\*  
(nr H-426-5011)



18 - Black Ulti-Matt  
(nr 000002-504700)



22 - Mahogany  
(nr UR601-U4)



30 - Walnut  
(nr UK103-Z8)



34 - Bog oak  
(nr H-436-2007)



38 Dark oak\*\*  
(nr H-426-2046)



42 - Woodec turner oak\*  
(nr 385308070001)



48 - Golden oak  
(nr UK101-Z8)



53 - Siena noce\*\*  
(nr 49237)



54 - Winchester  
(nr 49240)



55 - sheffield oak\*  
(nr 456-3081)



61 - Grey quartz\*  
(nr KADF8-Z8)



62 - Basalt grey\*  
(nr KADF9-Z8)



63 - Plain basalt grey\*  
(nr KADF9-F7)

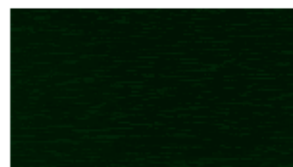

66 - Green\*  
(nr H-426-5021)



94 - Light grey  
(nr KACH7-Z8)



95 - Brushed aluminium\*  
(nr DJ606-42)

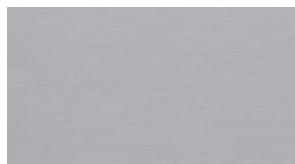

96 - Light silver\*\*  
(nr SS101-89)



97 - grafit metallic  
(nr D2573-F7)



99 - Dark grey  
(nr KACV8-Z8)

\* - Completion date up to 21 business days.

NOTE - the colour samples presented above can to some extent vary from the actual colours.



